

TL05x, TL05xA ENHANCED-JFET LOW-OFFSET OPERATIONAL AMPLIFIERS

SLOS178A – FEBRUARY 1997 - REVISED FEBRUARY 2003

- Direct Upgrades to TL07x and TL08x BiFET Operational Amplifiers
- Faster Slew Rate (20 V/ μ s Typ) Without Increased Power Consumption
- On-Chip Offset-Voltage Trimming for Improved DC Performance and Precision Grades Are Available (1.5 mV, TL051A)

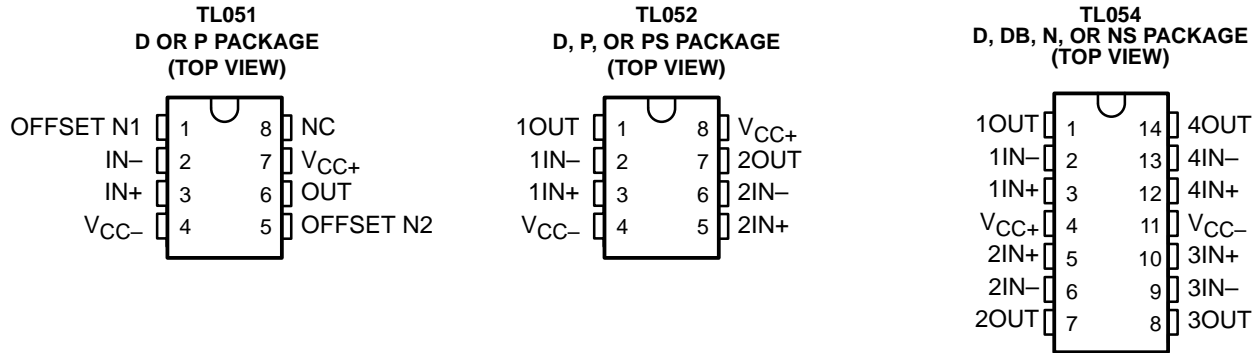

description/ordering information

The TL05x series of JFET-input operational amplifiers offers improved dc and ac characteristics over the TL07x and TL08x families of BiFET operational amplifiers. On-chip Zener trimming of offset voltage yields precision grades as low as 1.5 mV (TL051A) for greater accuracy in dc-coupled applications. Texas Instruments improved BiFET process and optimized designs also yield improved bandwidth and slew rate without increased power consumption. The TL05x devices are pin-compatible with the TL07x and TL08x and can be used to upgrade existing circuits or for optimal performance in new designs.

BiFET operational amplifiers offer the inherently higher input impedance of the JFET-input transistors, without sacrificing the output drive associated with bipolar amplifiers. This makes them better suited for interfacing with high-impedance sensors or very low-level ac signals. They also feature inherently better ac response than bipolar or CMOS devices having comparable power consumption.

The TL05x family was designed to offer higher precision and better ac response than the TL08x, with the low noise floor of the TL07x. Designers requiring significantly faster ac response or ensured lower noise should consider the Excalibur TLE208x and TLE207x families of BiFET operational amplifiers.

Because BiFET operational amplifiers are designed for use with dual power supplies, care must be taken to observe common-mode input voltage limits and output swing when operating from a single supply. DC biasing of the input signal is required, and loads should be terminated to a virtual-ground node at mid-supply. Texas Instruments TLE2426 integrated virtual ground generator is useful when operating BiFET amplifiers from single supplies.

The TL05x are fully specified at ± 15 V and ± 5 V. For operation in low-voltage and/or single-supply systems, Texas Instruments LinCMOS families of operational amplifiers (TLC-prefix) are recommended. When moving from BiFET to CMOS amplifiers, particular attention should be paid to the slew rate and bandwidth requirements, and also the output loading.



Please be aware that an important notice concerning availability, standard warranty, and use in critical applications of Texas Instruments semiconductor products and disclaimers thereto appears at the end of this data sheet.

PRODUCTION DATA information is current as of publication date. Products conform to specifications per the terms of Texas Instruments standard warranty. Production processing does not necessarily include testing of all parameters.

**TEXAS
INSTRUMENTS**

POST OFFICE BOX 655303 • DALLAS, TEXAS 75265

Copyright © 2003, Texas Instruments Incorporated

TL05x, TL05xA
ENHANCED-JFET LOW-OFFSET
OPERATIONAL AMPLIFIERS

SLOS178A – FEBRUARY 1997 - REVISED FEBRUARY 2003

ORDERING INFORMATION

T_A	V_{IOMAX} AT 25°C	PACKAGE†		ORDERABLE PART NUMBER	TOP-SIDE MARKING		
0°C to 70°C	800 μV	PDIP (P)	Tube of 50	TL051ACP	TL051ACP		
				TL052ACP	TL052ACP		
		SOIC (D)	Tube of 75	TL051ACD	051AC		
				TL052ACD	052AC		
			Reel of 2500	TL052ACDR			
				1.5 mV	PDIP (P)	Tube of 50	TL051CP
	TL052CP	TL052CP					
	PDIP (N)	Tube of 25	TL054ACN		TL054ACN		
			SOIC (D)		Tube of 75	TL051CD	TL051C
	Reel of 2500	TL051CDR					
	Tube of 75	TL052CD			TL052C		
		Reel of 2500				TL052CDR	
	Tube of 50	TL054ACD	TL054C				
		Reel of 2500			TL054ACDR		
	SOP (PS)	Reel of 2000	TL052CPSR		TL052		
	SSOP (DB)	Reel of 2000	TL054CDBR	TL054			
	4 mV	PDIP (N)	Tube of 25	TL054CN	TL054CN		
				SOIC (D)	Tube of 50	TL054CD	TL054C
						Reel of 2500	
		SOP (NS)	Reel of 2000	TL054CNSR	TL054		
-40°C to 85°C		800 μV	PDIP (P)	Tube of 50	TL052AIP	TL052AI	
	SOIC (D)				Tube of 75	TL052AID	052AI
			Reel of 2500	TL052AIDR			
	1.5 mV	PDIP (N)	Tube of 25	TL054AIN	TL054AIN		
				PDIP (P)	Tube of 50	TL051IP	TL051IP
		TL052IP	TL052IP				
		SOIC (D)	Tube of 75	TL051ID	TL051I		
				Tube of 75	TL052ID	TL052I	
			Reel of 2500	TL052IDR			
			Tube of 50	TL054AID	TL054AI		
		Reel of 2500		TL054AIDR			
	4 mV	PDIP (N)	Tube of 25	TL054IN	TL054IN		
				SOIC (D)	Tube of 50	TL054ID	TL054I
		Reel of 2500	TL054IDR				

† Package drawings, standard packing quantities, thermal data, symbolization, and PCB design guidelines are available at www.ti.com/sc/package.



TL05x, TL05xA ENHANCED-JFET LOW-OFFSET OPERATIONAL AMPLIFIERS

SLOS178A – FEBRUARY 1997 - REVISED FEBRUARY 2003

symbol (each amplifier)

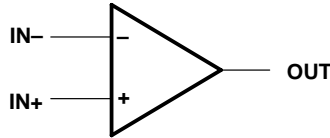

equivalent schematic (each amplifier)

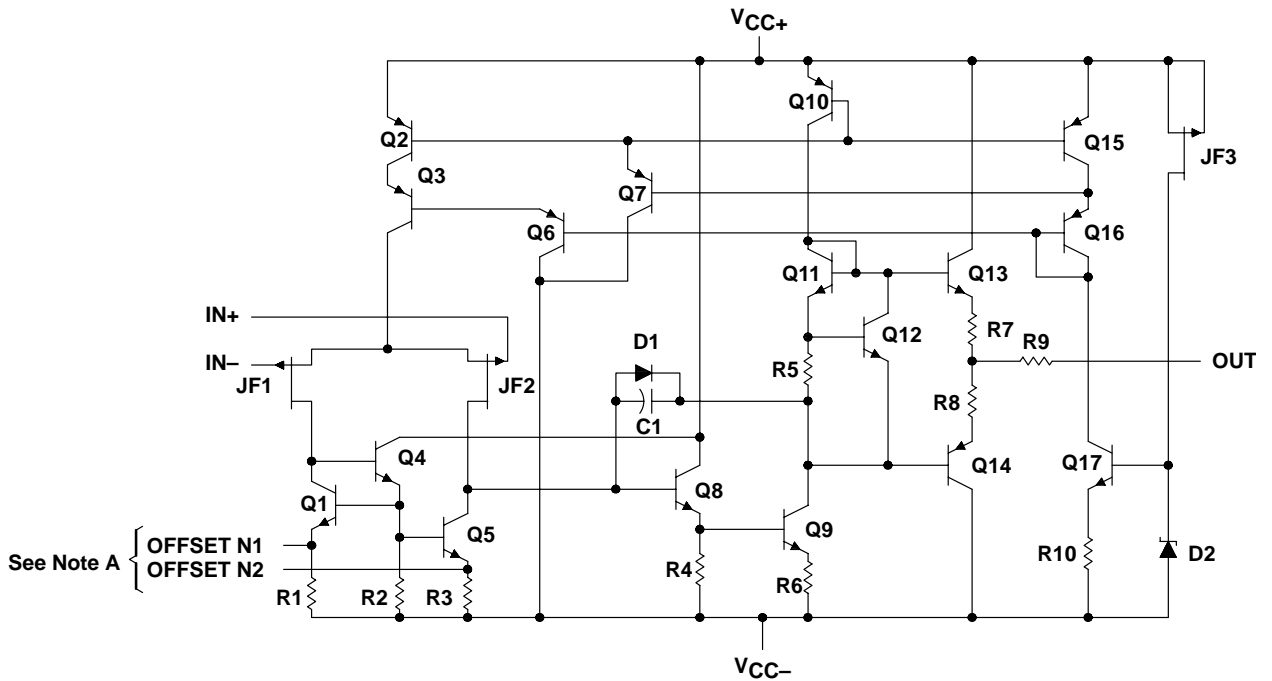

NOTE A: OFFSET N1 and OFFSET N2 are available only on the TL051x.

ACTUAL DEVICE COMPONENT COUNT†			
COMPONENT	TL051	TL052	TL054
Transistors	20	34	62
Resistors	10	19	37
Diodes	2	3	5
Capacitors	1	2	4

† These figures include all four amplifiers and all ESD, bias, and trim circuitry.

TL05x, TL05xA ENHANCED-JFET LOW-OFFSET OPERATIONAL AMPLIFIERS

SLOS178A – FEBRUARY 1997 - REVISED FEBRUARY 2003

absolute maximum ratings over operating free-air temperature range (unless otherwise noted)†

Supply voltage, V_{CC+} (see Note 1)	18 V
Supply voltage, V_{CC-} (see Note 1)	-18 V
Differential input voltage (see Note 2)	± 30 V
Input voltage range, V_I (any input, see Notes 1 and 3)	± 15 V
Input current, I_I (each input)	± 1 mA
Output current, I_O (each output)	± 80 mA
Total current into V_{CC+}	160 mA
Total current out of V_{CC-}	160 mA
Duration of short-circuit current at (or below) 25°C	Unlimited
Package thermal impedance, θ_{JA} (see Notes 4 and 5):	
D package (8 pin)	97°C/W
D package (14 pin)	86°C/W
DB package (14 pin)	96°C/W
N package (14 pin)	80°C/W
NS package (14 pin)	76°C/W
P package (8 pin)	85°C/W
PS package (8 pin)	95°C/W
Operating virtual junction temperature, T_J	150°C
Lead temperature 1,6 mm (1/16inch) from case for 10 seconds	260°C
Storage temperature range	-65°C to 150°C

† Stresses beyond those listed under “absolute maximum ratings” may cause permanent damage to the device. These are stress ratings only, and functional operation of the device at these or any other conditions beyond those indicated under “recommended operating conditions” is not implied. Exposure to absolute-maximum-rated conditions for extended periods may affect device reliability.

- NOTES:
1. All voltage values, except differential voltages, are with respect to the midpoint between V_{CC+} and V_{CC-} .
 2. Differential voltages are at $IN+$ with respect to $IN-$.
 3. The magnitude of the input voltage must never exceed the magnitude of the supply voltage or 15 V, whichever is less.
 4. Maximum power dissipation is a function of $T_J(max)$, θ_{JA} , and T_A . The maximum allowable power dissipation at any allowable ambient temperature is $P_D = (T_J(max) - T_A)/\theta_{JA}$. Operating at the absolute maximum T_J of 150°C can impact reliability.
 5. The package thermal impedance is calculated in accordance with JESD 51-7.

recommended operating conditions

		C SUFFIX		I SUFFIX		UNIT
		MIN	MAX	MIN	MAX	
$V_{CC\pm}$	Supply voltage	± 5	± 15	± 5	± 15	V
V_{IC}	Common-mode input voltage	$V_{CC\pm} = \pm 5$ V		-1	4	V
		$V_{CC\pm} = \pm 15$ V		-11	11	
T_A	Operating free-air temperature	0	70	-40	85	°C



TL05x, TL05xA
ENHANCED-JFET LOW-OFFSET
OPERATIONAL AMPLIFIERS

SLOS178A – FEBRUARY 1997 - REVISED FEBRUARY 2003

TL051C and TL051AC electrical characteristics at specified free-air temperature

PARAMETER	TEST CONDITIONS	T _A †	TL051C, TL051AC						UNIT
			V _{CC±} = ±5 V			V _{CC±} = ±15 V			
			MIN	TYP	MAX	MIN	TYP	MAX	
V _{IO} Input offset voltage		TL051C	25°C	0.75 3.5		0.59 1.5		mV	
			Full range	4.5		2.5			
		TL051AC	25°C	0.55 2.8		0.35 0.8			
			Full range	3.8		1.8			
α _{V_{IO}} Temperature coefficient of input offset voltage‡	V _O = 0, V _{IC} = 0, R _S = 50 Ω	TL051C	25°C to 70°C	8		8		μV/°C	
		TL051AC	25°C to 70°C	8		8 25			
Input offset-voltage long-term drift§		25°C	0.04		0.04		μV/mo		
I _{IO} Input offset current	V _O = 0, V _{IC} = 0, See Figure 5	25°C	4 100		5 100		pA		
		70°C	0.02 1		0.025 1		nA		
I _{IB} Input bias current	V _O = 0, V _{IC} = 0, See Figure 5	25°C	20 200		30 200		pA		
		70°C	0.15 4		0.2 4		nA		
V _{ICR} Common-mode input voltage range		25°C	-1 to 4	-2.3 to 5.6	-11 to 11	-12.3 to 15.6	V		
		Full range	-1 to 4		-11 to 11				
V _{OM+} Maximum positive peak output voltage swing	R _L = 10 kΩ	25°C	3 4.2		13 13.9		V		
		Full range	3		13				
	R _L = 2 kΩ	25°C	2.5 3.8		11.5 12.7				
		Full range	2.5		11.5				
V _{OM-} Maximum negative peak output voltage swing	R _L = 10 kΩ	25°C	-2.5 -3.5		-12 -13.2		V		
		Full range	-2.5		-12				
	R _L = 2 kΩ	25°C	-2.3 -3.2		-11 -12				
		Full range	-2.3		-11				
A _{VD} Large-signal differential voltage amplification¶	R _L = 2 kΩ	25°C	25 59		50 105		V/mV		
		0°C	30 65		60 129				
		70°C	20 46		30 85				
r _i Input resistance		25°C	10 ¹²		10 ¹²		Ω		
c _i Input capacitance		25°C	10		12		pF		
CMRR Common-mode rejection ratio	V _{IC} = V _{ICRmin} , V _O = 0, R _S = 50 Ω	25°C	65 85		75 93		dB		
		0°C	65 84		75 92				
		70°C	65 84		75 91				
k _{SVR} Supply-voltage rejection ratio (ΔV _{CC±} /ΔV _{IO})	V _O = 0, R _S = 50 Ω	25°C	75 99		75 99		dB		
		0°C	75 98		75 98				
		70°C	75 97		75 97				
I _{CC} Supply current	V _O = 0, No load	25°C	2.6 3.2		2.7 3.2		mA		
		0°C	2.7 3.2		2.8 3.2				
		70°C	2.6 3.2		2.7 3.2				

† Full range is 0°C to 70°C.

‡ This parameter is tested on a sample basis for the TL051A. For other test requirements, please contact the factory. This statement has no bearing on testing or nontesting of other parameters.

§ Typical values are based on the input offset-voltage shift observed through 168 hours of operating life test at T_A = 150°C, extrapolated to T_A = 25°C using the Arrhenius equation, and assuming an activation energy of 0.96 eV.

¶ For V_{CC±} = ±5 V, V_O = ±2.3 V, or for V_{CC±} = ±15 V, V_O = ±10 V.



TL05x, TL05xA ENHANCED-JFET LOW-OFFSET OPERATIONAL AMPLIFIERS

SLOS178A – FEBRUARY 1997 - REVISED FEBRUARY 2003

TL051C and TL051AC operating characteristics at specified free-air temperature

PARAMETER	TEST CONDITIONS	T _A †	TL051C, TL051AC						UNIT	
			V _{CC±} = ±5 V			V _{CC±} = ±15 V				
			MIN	TYP	MAX	MIN	TYP	MAX		
SR+	Positive slew rate at unity gain‡	25°C	16			13 20			V/μs	
			Full range	16.4			11 22.6			
SR-	Negative slew rate at unity gain‡	25°C	15			13 18				
			Full range	16			11 19.3			
t _r	Rise time	25°C	55			56				ns
		0°C	54			55				
		70°C	63			63				
t _f	Fall time	25°C	55			57				
		0°C	54			56				
		70°C	62			64				
Overshoot factor		25°C	24			19			%	
		0°C	24			19				
		70°C	24			19				
V _n	Equivalent input noise voltage§	25°C	f = 10 Hz	75			75			nV/√Hz
			f = 1 kHz	18			18 30			
V _{N(PP)}	Peak-to-peak equivalent input noise voltage	25°C	f = 10 Hz to 10 kHz	4			4			μV
I _n	Equivalent input noise current	25°C	f = 1 kHz	0.01			0.01			pA/√Hz
THD	Total harmonic distortion¶	25°C	R _S = 1 kΩ, f = 1 kHz, R _L = 2 kΩ	0.003			0.003			%
B ₁	Unity-gain bandwidth	25°C	V _I = 10 mV, C _L = 25 pF, R _L = 2 kΩ, See Figure 4	3			3.1			MHz
		0°C		3.2			3.3			
		70°C		2.7			2.8			
φ _m	Phase margin at unity gain	25°C	V _I = 10 mV, C _L = 25 pF, R _L = 2 kΩ, See Figure 4	59			62			deg
		0°C		58			62			
		70°C		59			62			

† Full range is 0°C to 70°C.

‡ For V_{CC±} = ±5 V, V_{I(PP)} = ±1 V; for V_{CC±} = ±15 V, V_{I(PP)} = ±5 V.

§ This parameter is tested on a sample basis for the TL051A. For other test requirements, please contact the factory. This statement has no bearing on testing or nontesting of other parameters.

¶ For V_{CC±} = ±5 V, V_{O(RMS)} = 1 V; for V_{CC±} = ±15 V, V_{O(RMS)} = 6 V.



TL05x, TL05xA
ENHANCED-JFET LOW-OFFSET
OPERATIONAL AMPLIFIERS

SLOS178A – FEBRUARY 1997 - REVISED FEBRUARY 2003

TL051I and TL051AI electrical characteristics at specified free-air temperature

PARAMETER	TEST CONDITIONS		T _A †	TL051I, TL051AI						UNIT
				V _{CC±} = ±5 V			V _{CC±} = ±15 V			
				MIN	TYP	MAX	MIN	TYP	MAX	
V _{IO} Input offset voltage		TL051I	25°C	0.75 3.5		0.59 1.5		mV		
			Full range	5.3		3.3				
			TL051AI	25°C	0.55 2.8		0.35 0.8			
				Full range	4.6		2.6			
α _{V_{IO}} Temperature coefficient of input offset voltage‡		TL051I	25°C to 85°C	7		8		μV/°C		
			TL051AI	25°C to 85°C	8		8 25			
Input offset-voltage long-term drift§			25°C	0.04		0.04		μV/mo		
I _{IO} Input offset current	V _O = 0, V _{IC} = 0, See Figure 5		25°C	4 100		5 100		pA		
			85°C	0.06 10		0.07 10		nA		
I _{IB} Input bias current	V _O = 0, V _{IC} = 0, See Figure 5		25°C	20 200		30 200		pA		
			85°C	0.6 20		0.7 20		nA		
V _{ICR} Common-mode input voltage range			25°C	-1 to 4 -2.3 to 5.6		-11 to 11 -12.3 to 15.6		V		
			Full range	-1 to 4		-11 to 11				
V _{OM+} Maximum positive peak output voltage swing	R _L = 10 kΩ		25°C	3 4.2		13 13.9		V		
			Full range	3		13				
	R _L = 2 kΩ	25°C	2.5 3.8		11.5 12.7					
		Full range	2.5		11.5					
V _{OM-} Maximum negative peak output voltage swing	R _L = 10 kΩ		25°C	-2.5 -3.5		-12 -13.2		V		
			Full range	-2.5		-12				
	R _L = 2 kΩ	25°C	-2.3 -3.2		-11 -12					
		Full range	-2.3		-11					
A _{VD} Large-signal differential voltage amplification¶	R _L = 2 kΩ		25°C	25 59		50 105		V/mV		
			-40°C	30 74		60 145				
			85°C	20 43		30 76				
r _i Input resistance			25°C	10 ¹²		10 ¹²		Ω		
c _i Input capacitance			25°C	10		12		pF		
CMRR Common-mode rejection ratio	V _{IC} = V _{ICRmin} , V _O = 0, R _S = 50 Ω		25°C	65 85		75 93		dB		
			-40°C	65 83		75 90				
			85°C	65 84		75 93				
k _{SVR} Supply-voltage rejection ratio (ΔV _{CC±} /ΔV _{IO})	V _O = 0, R _S = 50 Ω		25°C	75 99		75 99		dB		
			-40°C	75 98		75 98				
			85°C	75 99		75 99				
I _{CC} Supply current	V _O = 0, No load		25°C	2.6 3.2		2.7 3.2		mA		
			-40°C	2.4 3.2		2.6 3.2				
			85°C	2.5 3.2		2.6 3.2				

† Full range is -40°C to 85°C

‡ This parameter is tested on a sample basis for the TL051A. For other test requirements, please contact the factory. This statement has no bearing on testing or nontesting of other parameters.

§ Typical values are based on the input offset-voltage shift observed through 168 hours of operating life test at T_A = 150°C, extrapolated to T_A = 25°C using the Arrhenius equation, and assuming an activation energy of 0.96 eV.

¶ For V_{CC±} = ±5 V, V_O = ±2.3 V, or for V_{CC±} = ±15 V, V_O = ±10 V.



TL05x, TL05xA ENHANCED-JFET LOW-OFFSET OPERATIONAL AMPLIFIERS

SLOS178A – FEBRUARY 1997 - REVISED FEBRUARY 2003

TL051I and TL051AI operating characteristics at specified free-air temperature

PARAMETER	TEST CONDITIONS	T _A †	TL051I, TL051AI						UNIT	
			V _{CC±} = ±5 V			V _{CC±} = ±15 V				
			MIN	TYP	MAX	MIN	TYP	MAX		
SR+	Positive slew rate at unity gain‡	R _L = 2 kΩ, C _L = 100 pF, See Figure 1	25°C	16			13	20		V/μs
			Full range				11			
SR-	Negative slew rate at unity gain‡	R _L = 2 kΩ, C _L = 100 pF, See Figure 1	25°C	15			13	18		
			Full range				11			
t _r	Rise time	V _{I(PP)} = ±10 mV, R _L = 2 kΩ, C _L = 100 pF, See Figures 1 and 2	25°C	55			56		ns	
t _f	Fall time		-40°C	52			53			
			85°C	64			65			
			25°C	55			57			
			-40°C	51			53			
Overshoot factor			85°C	64			65			
		25°C	24			19		%		
		-40°C	24			19				
V _n	Equivalent input noise voltage§	R _S = 20 Ω, See Figure 3	f = 10 Hz	75			75		nV/√Hz	
			f = 1 kHz	18			18 30			
V _{N(PP)}	Peak-to-peak equivalent input noise voltage	f = 10 Hz to 10 kHz	4			4		μV		
I _n	Equivalent input noise current	f = 1 kHz	25°C	0.01			0.01		pA/√Hz	
THD	Total harmonic distortion¶	R _S = 1 kΩ, f = 1 kHz, R _L = 2 kΩ	25°C	0.003			0.003		%	
B ₁	Unity-gain bandwidth	V _I = 10 mV, C _L = 25 pF, R _L = 2 kΩ, See Figure 4	25°C	3			3.1		MHz	
			-40°C	3.5			3.6			
			85°C	2.6			2.7			
φ _m	Phase margin at unity gain	V _I = 10 mV, C _L = 25 pF, R _L = 2 kΩ, See Figure 4	25°C	59			62		deg	
			-40°C	58			61			
			85°C	59			62			

† Full range is -40°C to 85°C.

‡ For V_{CC±} = ±5 V, V_{I(PP)} = ±1 V; for V_{CC±} = ±15 V, V_{I(PP)} = ±5 V.

§ This parameter is tested on a sample basis for the TL051A. For other test requirements, please contact the factory. This statement has no bearing on testing or nontesting of other parameters.

¶ For V_{CC±} = ±5 V, V_{O(RMS)} = 1 V; for V_{CC±} = ±15 V, V_{O(RMS)} = 6 V.



TL05x, TL05xA
ENHANCED-JFET LOW-OFFSET
OPERATIONAL AMPLIFIERS

SLOS178A – FEBRUARY 1997 - REVISED FEBRUARY 2003

TL052C and TL052AC electrical characteristics at specified free-air temperature

PARAMETER	TEST CONDITIONS		T _A †	TL052C, TL052AC						UNIT
				V _{CC±} = ±5 V			V _{CC±} = ±15 V			
				MIN	TYP	MAX	MIN	TYP	MAX	
V _{IO} Input offset voltage		TL052C	25°C	0.73 3.5		0.65 1.5		mV		
			Full range	4.5		2.5				
			TL052AC	25°C	0.51 2.8		0.4 0.8			
				Full range	3.8		1.8			
α _{V_{IO}} Temperature coefficient of input offset voltage‡		TL052C	25°C to 70°C	8		8		μV/°C		
			TL052AC	25°C to 70°C	8		6 25			
Input offset-voltage long-term drift§	V _O = 0, R _S = 50 Ω	V _{IC} = 0,	25°C	0.04		0.04		μV/mo		
I _{IO} Input offset current	V _O = 0, See Figure 5	V _{IC} = 0,	25°C	4 100		5 100		pA		
			70°C	0.02 1		0.025 1		nA		
I _{IB} Input bias current	V _O = 0, See Figure 5	V _{IC} = 0,	25°C	20 200		30 200		pA		
			70°C	0.15 4		0.2 4		nA		
V _{ICR} Common-mode input voltage range			25°C	-1 to 4 -2.3 to 5.6		-11 to 11 -12.3 to 15.6		V		
			Full range	-1 to 4		-11 to 11				
V _{OM+} Maximum positive peak output voltage swing	R _L = 10 kΩ		25°C	3 4.2		13 13.9		V		
			Full range	3		13				
	R _L = 2 kΩ	25°C	2.5 3.8		11.5 12.7					
		Full range	2.5		11.5					
V _{OM-} Maximum negative peak output voltage swing	R _L = 10 kΩ		25°C	-2.5 -3.5		-12 -13.2		V		
			Full range	-2.5		-12				
	R _L = 2 kΩ	25°C	-2.3 -3.2		-11 -12					
		Full range	-2.3		-11					
A _{VD} Large-signal differential voltage amplification¶	R _L = 2 kΩ		25°C	25 59		50 105		V/mV		
			0°C	30 65		60 129				
			70°C	20 46		30 85				
r _i Input resistance			25°C	10 ¹²		10 ¹²		Ω		
c _i Input capacitance			25°C	10		12		pF		
CMRR Common-mode rejection ratio	V _{IC} = V _{ICRmin} , V _O = 0,	R _S = 50 Ω	25°C	65 85		75 93		dB		
			0°C	65 84		75 92				
			70°C	65 84		75 91				

† Full range is 0°C to 70°C.

‡ This parameter is tested on a sample basis. For other test requirements, please contact the factory. This statement has no bearing on testing or nontesting of other parameters.

§ Typical values are based on the input offset-voltage shift observed through 168 hours of operating life test at T_A = 150°C, extrapolated to T_A = 25°C using the Arrhenius equation, and assuming an activation energy of 0.96 eV.

¶ For V_{CC±} = ±5 V, V_O = ±2.3 V; at V_{CC±} = ±15 V, V_O = ±10 V.



TL05x, TL05xA ENHANCED-JFET LOW-OFFSET OPERATIONAL AMPLIFIERS

SLOS178A – FEBRUARY 1997 - REVISED FEBRUARY 2003

TL052C and TL052AC electrical characteristics at specified free-air temperature (continued)

PARAMETER	TEST CONDITIONS	T _A	TL052C, TL052AC						UNIT	
			V _{CC±} = ±5 V			V _{CC±} = ±15 V				
			MIN	TYP	MAX	MIN	TYP	MAX		
k _{SVR}	Supply-voltage rejection ratio (ΔV _{CC±} /ΔV _{IO})	V _O = 0, R _S = 50 Ω	25°C	75	99		75	99	dB	
			0°C	75	98		75	98		
			70°C	75	97		75	97		
I _{CC}	Supply current (two amplifiers)	V _O = 0, No load	25°C		4.6	5.6		4.8	5.6	mA
			0°C		4.7	6.4		4.8	6.4	
			70°C		4.4	6.4		4.6	6.4	
V _{O1} /V _{O2}	Crosstalk attenuation	A _{VD} = 100	25°C		120			120	dB	

TL052C and TL052AC operating characteristics at specified free-air temperature

PARAMETER	TEST CONDITIONS	T _A †	TL052C, TL052AC						UNIT
			V _{CC±} = ±5 V			V _{CC±} = ±15 V			
			MIN	TYP	MAX	MIN	TYP	MAX	
SR+	Slew rate at unity gain	R _L = 2 kΩ, C _L = 100 pF, See Figure 1	25°C		17.8		9	20.7	V/μs
SR-	Negative slew rate at unity gain‡		Full range				8		
			25°C		15.4		9	17.8	
			Full range				8		
t _r	Rise time	V _{I(PP)} = ±10 mV, R _L = 2 kΩ, C _L = 100 pF, See Figures 1 and 2	25°C		55			56	ns
			0°C		54			55	
			70°C		63			63	
t _f	Fall time		25°C		55			57	
			0°C		54			56	
			70°C		62			64	
	Overshoot factor		25°C		24			19	%
			0°C		24			19	
			70°C		24			19	
V _n	Equivalent input noise voltage§	R _S = 20 Ω, See Figure 3	f = 10 Hz	25°C		71		71	nV/√Hz
			f = 1 kHz	25°C		19		19	
V _{N(PP)}	Peak-to-peak equivalent input noise current		f = 10 Hz to 10 kHz	25°C		4		4	μV
I _n	Equivalent input noise current	f = 1 kHz	25°C		0.01			0.01	pA/√Hz
THD	Total harmonic distortion¶	R _S = 1 kΩ, R _L = 2 kΩ, f = 1 kHz	25°C		0.003			0.003	%
B ₁	Unity-gain bandwidth	V _I = 10 mV, R _L = 2 kΩ, C _L = 25 pF, See Figure 4	25°C		3			3	MHz
			0°C		3.2			3.2	
			70°C		2.6			2.7	
φ _m	Phase margin at unity gain	V _I = 10 mV, R _L = 2 kΩ, C _L = 25 pF, See Figure 4	25°C		60			63	deg
			0°C		59			63	
			70°C		60			63	

† Full range is 0°C to 70°C.

‡ For V_{CC±} = ±5 V, V_{I(PP)} = ±1 V; for V_{CC±} = ±15 V, V_{I(PP)} = ±5 V.

§ This parameter is tested on a sample basis. For other test requirements, please contact the factory. This statement has no bearing on testing or nontesting of other parameters.

¶ For V_{CC±} = ±5 V, V_{O(RMS)} = 1 V; for V_{CC±} = ±15 V, V_{O(RMS)} = 6 V.



TL05x, TL05xA ENHANCED-JFET LOW-OFFSET OPERATIONAL AMPLIFIERS

SLOS178A – FEBRUARY 1997 - REVISED FEBRUARY 2003

TL052I and TL052AI electrical characteristics at specified free-air temperature

PARAMETER	TEST CONDITIONS		T _A †	TL052I, TL052AI						UNIT
				V _{CC±} = ±5 V			V _{CC±} = ±15 V			
				MIN	TYP	MAX	MIN	TYP	MAX	
V _{IO} Input offset voltage		TL052I	25°C	0.73 3.5		0.65 1.5		mV		
			Full range	5.3		3.3				
			TL052AI	25°C	0.51 2.8		0.4 0.8			
				Full range	4.6		2.6			
α _{V_{IO}} Temperature coefficient‡		TL052I	25°C to 85°C	7		6		μV/°C		
			TL052AI	25°C to 85°C	6		6 25			
Input offset-voltage long-term drift§	V _O = 0, R _S = 50 Ω	V _{IC} = 0,	25°C	0.04		0.04		μV/mo		
I _{IO} Input offset current	V _O = 0, See Figure 5	V _{IC} = 0,	25°C	4 100		5 100		pA		
			85°C	0.06 10		0.07 10		nA		
I _{IB} Input bias current	V _O = 0, See Figure 5	V _{IC} = 0,	25°C	20 200		30 200		pA		
			85°C	0.6 20		0.7 20		nA		
V _{ICR} Common-mode input voltage range			25°C	-1 to 4	-2.3 to 5.6	-11 to 11	-12.3 to 15.6	V		
			Full range	-1 to 4		-11 to 11				
V _{OM+} Maximum positive peak output voltage swing	R _L = 10 kΩ		25°C	3 4.2		13 13.9		V		
			Full range	3		13				
	R _L = 2 kΩ	25°C	2.5 3.8		11.5 12.7					
		Full range	2.5		11.5					
V _{OM-} Maximum negative peak output voltage swing	R _L = 10 kΩ		25°C	-2.5 -3.5		-12 -13.2		V		
			Full range	-2.5		-12				
	R _L = 2 kΩ	25°C	-2.3 -3.2		-11 -12					
		Full range	-2.3		-11					
A _{VD} Large-signal differential voltage amplification¶	R _L = 2 kΩ		25°C	25 59		50 105		V/mV		
			-40°C	30 74		60 145				
			85°C	20 43		30 76				
r _i Input resistance			25°C	10 ¹²		10 ¹²		Ω		
c _i Input capacitance			25°C	10		12		pF		
CMRR Common-mode rejection ratio	V _{IC} = V _{ICRmin} , V _O = 0,	R _S = 50 Ω	25°C	65 85		75 93		dB		
			-40°C	65 83		75 90				
			85°C	65 84		75 93				

† Full range is -40°C to 85°C.

‡ This parameter is tested on a sample basis. For other test requirements, please contact the factory. This statement has no bearing on testing or nontesting of other parameters

§ Typical values are based on the input offset-voltage shift observed through 168 hours of operating life test at T_A = 150°C, extrapolated to T_A = 25°C using the Arrhenius equation, and assuming an activation energy of 0.96 eV.

¶ At V_{CC±} = ±5 V, V_O = ±2.3 V; at V_{CC±} = ±15 V, V_O = ±10 V.



TL05x, TL05xA ENHANCED-JFET LOW-OFFSET OPERATIONAL AMPLIFIERS

SLOS178A – FEBRUARY 1997 - REVISED FEBRUARY 2003

TL052I and TL052AI electrical characteristics at specified free-air temperature (continued)

PARAMETER	TEST CONDITIONS	T _A	TL052I, TL052AI						UNIT	
			V _{CC±} = ±5 V			V _{CC±} = ±15 V				
			MIN	TYP	MAX	MIN	TYP	MAX		
k _{SVR}	Supply-voltage rejection ratio (ΔV _{CC±} /ΔV _{IO})	V _O = 0, R _S = 50 Ω	25°C	75	99		75	99	dB	
			-40°C	75	98		75	98		
			85°C	75	99		75	99		
I _{CC}	Supply current (two amplifiers)	V _O = 0, No load	25°C		4.6	5.6		4.8	5.6	mA
			-40°C		4.5	6.4		4.7	6.4	
			85°C		4.4	6.4		4.6	6.4	
V _{O1} /V _{O2}	Crosstalk attenuation	A _V D = 100	25°C		120			120	dB	

TL052I and TL052AI operating characteristics at specified free-air temperature

PARAMETER	TEST CONDITIONS	T _A †	TL052I, TL052AI						UNIT	
			V _{CC±} = ±5 V			V _{CC±} = ±15 V				
			MIN	TYP	MAX	MIN	TYP	MAX		
SR+	Slew rate at unity gain‡	R _L = 2 kΩ, C _L = 100 pF, See Figure 1	25°C		17.8		9	20.7	V/μs	
			Full range				8			
SR-	Negative slew rate at unity gain‡		25°C		15.4		9	17.8		
			Full range				8			
t _r	Rise time	V _{I(PP)} = ±10 mV, R _L = 2 kΩ, C _L = 100 pF, See Figures 1 and 2	25°C		55			56	ns	
			-40°C		52			53		
			85°C		64			65		
t _f	Fall time		25°C		55			57		
			-40°C		51			53		
			85°C		64			65		
	Overshoot factor		25°C		24%			19%	%	
			-40°C		24%			19%		
			85°C		24%			19%		
V _n	Equivalent input noise voltage§	R _S = 20 Ω, See Figure 3	f = 10 Hz	25°C		71		71	nV/√Hz	
			f = 1 kHz	25°C		19		19		30
V _{N(PP)}	Peak-to-peak equivalent input noise current		f = 10 Hz to 10 kHz	25°C		4		4		μV
I _n	Equivalent input noise current	f = 1 kHz	25°C		0.01		0.01	pA/√Hz		
THD	Total harmonic distortion¶	R _S = 1 kΩ, f = 1 kHz, R _L = 2 kΩ	25°C		0.003		0.003	%		
B ₁	Unity-gain bandwidth	V _I = 10 mV, C _L = 25 pF, R _L = 2 kΩ, See Figure 4	25°C		3		3	MHz		
			-40°C		3.5		3.6			
			85°C		2.5		2.6			
φ _m	Phase margin at unity gain	V _I = 10 mV, C _L = 25 pF, R _L = 2 kΩ, See Figure 4	25°C		60		63	deg		
			-40°C		58		61			
			85°C		60		63			

† Full range is -40°C to 85°C.

‡ For V_{CC±} = ±5 V, V_{I(PP)} = ±1 V; for V_{CC±} = ±15 V, V_{I(PP)} = ±5 V.

§ This parameter is tested on a sample basis. For other test requirements, please contact the factory. This statement has no bearing on testing or nontesting of other parameters.

¶ For V_{CC±} = ±5 V, V_{O(RMS)} = 1 V; for V_{CC±} = ±15 V, V_{O(RMS)} = 6 V.



TL05x, TL05xA
ENHANCED-JFET LOW-OFFSET
OPERATIONAL AMPLIFIERS

SLOS178A – FEBRUARY 1997 - REVISED FEBRUARY 2003

TL054C and TL054AC electrical characteristics at specified free-air temperature

PARAMETER	TEST CONDITIONS	T _A †	TL054C, TL054AC						UNIT			
			V _{CC±} = ±5 V			V _{CC±} = ±15 V						
			MIN	TYP	MAX	MIN	TYP	MAX				
V _{IO}	Input offset voltage	TL054C	25°C	0.64		5.5		0.56		4		
			Full range			7.7				6.2		
			TL054AC	25°C	0.57		3.5		0.5		1.5	
				Full range			5.7				3.7	
α _{V_{IO}}	Temperature coefficient of input offset voltage	TL054C	25°C to 70°C	25				23				
			TL054AC	25°C to 70°C	24				23			
	Input offset-voltage long-term drift‡		25°C	0.04				0.04		μV/mo		
I _{IO}	Input offset current	V _O = 0, V _{IC} = 0, See Figure 5	25°C	4		100		5		100		
			70°C	0.02		1		0.025		1		
I _{IB}	Input bias current	V _O = 0, V _{IC} = 0, See Figure 5	25°C	20		200		30		200		
			70°C	0.15		4		0.2		4		
V _{ICR}	Common-mode input voltage range		25°C	-1 to 4	-2.3 to 5.6			-11 to 11	-12.3 to 15.6			
			Full range	-1 to 4				-11 to 11				
V _{OM+}	Maximum positive peak output voltage swing	R _L = 10 kΩ	25°C	3		4.2		13		13.9		
			Full range	3				13				
		R _L = 2 kΩ	25°C	2.5		3.8		11.5		12.7		
			Full range	2.5				11.5				
V _{OM-}	Maximum negative peak output voltage swing	R _L = 10 kΩ	25°C	-2.5		-3.5		-12		-13.2		
			Full range	-2.5				-12				
		R _L = 2 kΩ	25°C	-2.3		-3.2		-11		-12		
			Full range	-2.3				-11				
A _{VD}	Large-signal differential voltage amplification§	R _L = 2 kΩ	25°C	25		72		50		133		
			0°C	30		88		60		173		
			70°C	20		57		30		85		
r _i	Input resistance		25°C	10 ¹²				10 ¹²		Ω		
c _i	Input capacitance		25°C	10				12		pF		
CMRR	Common-mode rejection ratio	V _{IC} = V _{ICRmin} , V _O = 0, R _S = 50 Ω	25°C	65		84		75		92		
			0°C	65		84		75		92		
			70°C	65		84		75		93		
k _{SVR}	Supply-voltage rejection ratio (ΔV _{CC±} /ΔV _{IO})	V _{CC±} = ±5 V to ±15 V, V _O = 0, R _S = 50 Ω	25°C	75		99		75		99		
			0°C	75		99		75		99		
			70°C	75		99		75		99		
I _{CC}	Supply current (four amplifiers)	V _O = 0, No load	25°C	8.1		11.2		8.4		11.2		
			0°C	8.2		12.8		8.5		12.8		
			70°C	7.9		11.2		8.2		11.2		
V _{O1} /V _{O2}	Crosstalk attenuation	A _{VD} = 100	25°C	120				120		dB		

† Full range is 0°C to 70°C.

‡ Typical values are based on the input offset-voltage shift observed through 168 hours of operating life test at T_A = 150°C, extrapolated to T_A = 25°C using the Arrhenius equation, and assuming an activation energy of 0.96 eV.

§ For V_{CC±} = ±5 V, V_O = ±2.3 V, at V_{CC±} = ±15 V, V_O = ±10 V.B



TL05x, TL05xA ENHANCED-JFET LOW-OFFSET OPERATIONAL AMPLIFIERS

SLOS178A – FEBRUARY 1997 - REVISED FEBRUARY 2003

TL054C and TL054AC operating characteristics at specified free-air temperature

PARAMETER	TEST CONDITIONS	T _A †	TL054C, TL054C						UNIT		
			V _{CC±} = ±5 V			V _{CC±} = ±15 V					
			MIN	TYP	MAX	MIN	TYP	MAX			
SR+	Positive slew rate at unity gain		25°C	15.4			10 17.8			V/μs	
			0°C	15.7			8 17.9				
			70°C	14.4			8 17.5				
SR-	Negative slew rate at unity gain‡	R _L = 2 kΩ, C _L = 100 pF, See Figure 1 and Note 7	25°C	13.9			10 15.9				
			0°C	14.3			8 16.1				
			70°C	13.3			8 15.5				
t _r	Rise time		25°C	55			56			ns	
			0°C	54			55				
			70°C	63			63				
t _f	Fall time	V _{I(PP)} = ±10 mV, R _L = 2 kΩ, C _L = 100 pF, See Figures 1 and 2	25°C	55			57				
			0°C	54			56				
			70°C	62			64				
	Overshoot factor		25°C	24%			19%			%	
			0°C	24%			19%				
			70°C	24%			19%				
V _n	Equivalent input noise voltage§	R _S = 20 Ω, See Figure 3	f = 10 Hz	25°C	75			75			nV/√Hz
			f = 1 kHz	25°C	21			21 45			
V _{N(PP)}	Peak-to-peak equivalent input noise voltage		f = 10 Hz to 10 kHz	25°C	4			4			μV
I _n	Equivalent input noise current	f = 1 kHz	25°C	0.01			0.01			pA/√Hz	
THD	Total harmonic distortion¶	R _S = 1 kΩ, R _L = 2 kΩ, f = 1 kHz	25°C	0.003			0.003			%	
B ₁	Unity-gain bandwidth	V _I = 10 mV, R _L = 2 kΩ, C _L = 25 pF, See Figure 4	25°C	2.7			2.7			MHz	
			0°C	3			3				
			70°C	2.4			2.4				
φ _m	Phase margin at unity gain	V _I = 10 mV, R _L = 2 kΩ, C _L = 25 pF, See Figure 4	25°C	61			64			deg	
			0°C	60			64				
			70°C	61			63				

† Full range is 0°C to 70°C.

‡ For V_{CC±} = ±5 V, V_{I(PP)} = ±1 V; for V_{CC±} = ±15 V, V_{I(PP)} = ±5 V.

§ This parameter is tested on a sample basis. For other test requirements, please contact the factory. This statement has no bearing on testing or nontesting of other parameters.

¶ For V_{CC±} = ±5 V, V_{O(RMS)} = 1 V; for V_{CC±} = ±15 V, V_{O(RMS)} = 6 V.



TL05x, TL05xA ENHANCED-JFET LOW-OFFSET OPERATIONAL AMPLIFIERS

SLOS178A – FEBRUARY 1997 - REVISED FEBRUARY 2003

TL054I and TL054AI electrical characteristics at specified free-air temperature

PARAMETER	TEST CONDITIONS	T _A †	TL054I, TL054AI						UNIT
			V _{CC±} = ±5 V			V _{CC±} = ±15 V			
			MIN	TYP	MAX	MIN	TYP	MAX	
V _{IO}	Input offset voltage	TL054I	25°C	0.64	5.5	0.56	4	mV	
			Full range	8.8			7.3		
			TL054AI	25°C	0.57	3.5	0.5		1.5
				Full range	6.8				4.8
α _{V_{IO}}	Temperature coefficient of input offset voltage	TL054I	25°C to 85°C	25		24		μV/°C	
		TL054AI	25°C to 85°C	25		23			
	Input offset voltage long-term drift‡		25°C	0.04		0.04		μV/mo	
I _{IO}	Input offset current	V _O = 0, V _{IC} = 0, See Figure 5	25°C	4	100	5	100	pA	
			85°C	0.06	10	0.07	10	nA	
I _{IB}	Input bias current	V _O = 0, V _{IC} = 0, See Figure 5	25°C	20	200	30	200	pA	
			85°C	0.6	20	0.7	20	nA	
V _{ICR}	Common-mode input voltage range		25°C	-1 to 4	-2.3 to 5.6	-11 to 11	-12.3 to 15.6	V	
			Full range	-1 to 4		-11 to 11			
V _{OM+}	Maximum positive peak output voltage swing	R _L = 10 kΩ	25°C	3	4.2	13	13.9	V	
			Full range	3		13			
		R _L = 2 kΩ	25°C	2.5	3.8	11.5	12.7		
			Full range	2.5		11.5			
V _{OM-}	Maximum negative peak output voltage swing	R _L = 10 kΩ	25°C	-2.5	-3.5	-12	-13.2	V	
			Full range	-2.5		-12			
		R _L = 2 kΩ	25°C	-2.3	-3.2	-11	-12		
			Full range	-2.3		-11			
A _{VD}	Large-signal differential voltage amplification§	R _L = 2 kΩ	25°C	25	72	50	133	V/mV	
			-40°C	30	101	60	212		
			85°C	20	50	30	70		
r _i	Input resistance		25°C	10 ¹²		10 ¹²		Ω	
c _i	Input capacitance		25°C	10		12		pF	
CMRR	Common-mode rejection ratio	V _{IC} = V _{ICRmin} , V _O = 0, R _S = 50 Ω	25°C	65	84	75	92	dB	
			-40°C	65	83	75	92		
			85°C	65	84	75	93		
k _{SVR}	Supply-voltage rejection ratio (ΔV _{CC±} /ΔV _{IO})	V _{CC±} = ±5 V to ±15 V, V _O = 0, R _S = 50 Ω	25°C	75	99	75	99	dB	
			-40°C	75	98	75	99		
			85°C	75	99	75	99		
I _{CC}	Supply current (four amplifiers)	V _O = 0, No load	25°C	8.1	11.2	8.4	11.2	mA	
			-40°C	7.9	12.8	8.2	12.8		
			85°C	7.6	11.2	7.9	11.2		
V _{O1} /V _{O2}	Crosstalk attenuation	A _{VD} = 100	25°C	120		120		dB	

† Full range is -40°C to 85°C.

‡ Typical values are based on the input offset voltage shift observed through 168 hours of operating life test at T_A = 150°C, extrapolated to T_A = 25°C using the Arrhenius equation, and assuming an activation energy of 0.96 eV.

§ For V_{CC±} = ±5 V, V_O = ±2.3 V, at V_{CC±} = ±15 V, V_O = ±10 V.



TL05x, TL05xA
ENHANCED-JFET LOW-OFFSET
OPERATIONAL AMPLIFIERS

SLOS178A – FEBRUARY 1997 - REVISED FEBRUARY 2003

TL054I and TL054AI operating characteristics at specified free-air temperature

PARAMETER	TEST CONDITIONS	T _A †	TL054I, TL054AI						UNIT		
			V _{CC±} = ±5 V			V _{CC±} = ±15 V					
			MIN	TYP	MAX	MIN	TYP	MAX			
SR+	Positive slew rate at unity gain	R _L = 2 kΩ, C _L = 100 pF, See Figure 1	25°C	15.4			10 17.8			V/μs	
			-40°C	16.4			8 18				
			85°C	14			8 17.3				
SR-	Negative slew rate at unity gain‡		25°C	13.9			10 15.9				
			-40°C	14.7			8 16.1				
			85°C	13			8 15.3				
t _r	Rise time	V _{I(PP)} = ±10 mV, R _L = 2 kΩ, C _L = 100 pF, See Figures 1 and 2	25°C	55			56			ns	
			-40°C	52			53				
			85°C	64			65				
t _f	Fall time		25°C	55			57				
			-40°C	51			53				
			85°C	64			65				
	Overshoot factor		25°C	24			19			%	
			-40°C	24			19				
			85°C	24			19				
V _n	Equivalent input noise voltage§	R _S = 20 Ω, See Figure 3	f = 10 Hz	25°C	75			75			nV/√Hz
			f = 1 kHz	25°C	21			21 45			
V _{N(PP)}	Peak-to-peak equivalent input noise voltage		f = 10 Hz to 10 kHz	25°C	4			4			μV
I _n	Equivalent input noise current	f = 1 kHz		25°C	0.01			0.01			pA/√Hz
THD	Total harmonic distortion¶	R _S = 1 kΩ, f = 1 kHz	R _L = 2 kΩ,	25°C	0.003%			0.003%			%
B ₁	Unity-gain bandwidth	V _I = 10 mV, C _L = 25 pF,	R _L = 2 kΩ, See Figure 4	25°C	2.7			2.7			MHz
				-40°C	3.3			3.3			
				85°C	2.3			2.4			
φ _m	Phase margin at unity gain	V _I = 10 mV, C _L = 25 pF,	R _L = 2 kΩ, See Figure 4	25°C	61			64			deg
				-40°C	59			62			
				85°C	61			64			

† Full range is -40°C to 85°C.

‡ For V_{CC±} = ±5 V, V_{I(PP)} = ±1 V; for V_{CC±} = ±15 V, V_{I(PP)} = ±5 V.

§ This parameter is tested on a sample basis. For other test requirements, please contact the factory. This statement has no bearing on testing or nontesting of other parameters.

¶ For V_{CC±} = ±5 V, V_{O(RMS)} = 1 V; for V_{CC±} = ±15 V, V_{O(RMS)} = 6 V.



PARAMETER MEASUREMENT INFORMATION

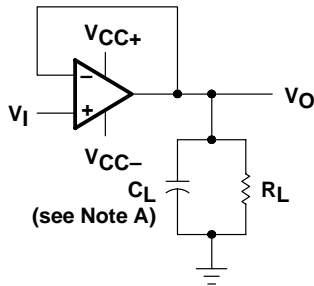

NOTE A: C_L includes fixture capacitance.

Figure 1. Slew Rate, Rise/Fall Time, and Overshoot Test Circuit

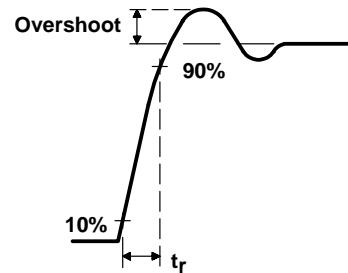

Figure 2. Rise-Time and Overshoot Waveform

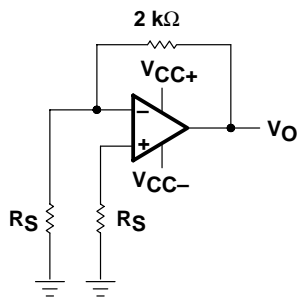
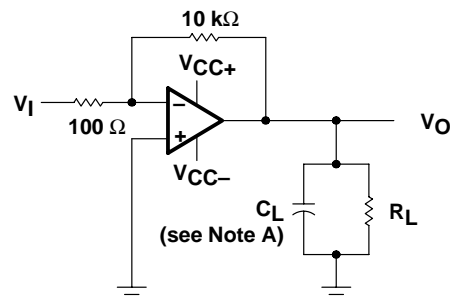

Figure 3. Noise-Voltage Test Circuit



NOTE A: C_L includes fixture capacitance.

Figure 4. Unity-Gain Bandwidth and Phase-Margin Test Circuit

typical values

Typical values, as presented in this data sheet represent the median (50% point) of device parametric performance.

input bias and offset current

At the picoamp-bias-current level typical of the TL05x and TL05xA, accurate measurement of the bias current becomes difficult. Not only does this measurement require a picoammeter, but test-socket leakages easily can exceed the actual device bias currents. To accurately measure these small currents, Texas Instruments uses a two-step process. The socket leakage is measured using picoammeters with bias voltages applied, but with no device in the socket. The device then is inserted in the socket, and a second test that measures both the socket leakage and the device input bias current is performed. The two measurements then are subtracted algebraically to determine the bias current of the device.

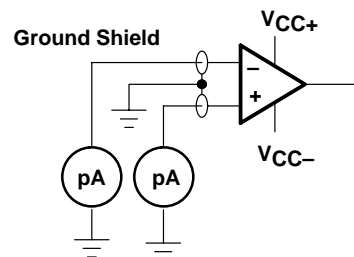

Figure 5. Input-Bias and Offset-Current Test Circuit

noise

Because of the increasing emphasis on low noise levels in many of today's applications, the input noise voltage density is sample tested at $f = 1$ kHz. Texas Instruments also has additional noise-testing capability to meet specific application requirements. Please contact the factory for details.

TL05x, TL05xA
ENHANCED-JFET LOW-OFFSET
OPERATIONAL AMPLIFIERS

SLOS178A – FEBRUARY 1997 - REVISED FEBRUARY 2003

TYPICAL CHARACTERISTICS

Table of Graphs

			FIGURE
V_{IO}	Input offset voltage	Distribution	6–11
$\alpha_{V_{IO}}$	Temperature coefficient of input offset voltage	Distribution	12, 13, 14
I_{IB}	Input bias current	vs Common-mode input voltage	15
		vs Free-air temperature	16
I_{IO}	Input offset current	vs Free-air temperature	16
V_{IC}	Common-mode input voltage range limits	vs Supply voltage	17
		vs Free-air temperature	18
V_O	Output voltage	vs Differential input voltage	19, 20
V_{OM}	Maximum peak output voltage	vs Supply voltage	21
		vs Output current	25, 26
		vs Free-air temperature	27, 28
$V_{O(PP)}$	Maximum peak-to-peak output voltage	vs Frequency	22, 23, 24
A_{VD}	Large-signal differential voltage amplification	vs Load resistance	29
		vs Frequency	30
		vs Free-air temperature	31, 32, 33
CMRR	Common-mode rejection ratio	vs Frequency	34, 35
		vs Free-air temperature	36
z_o	Output impedance	vs Frequency	37
k_{SVR}	Supply-voltage rejection ratio	vs Free-air temperature	38
I_{OS}	Short-circuit output current	vs Supply voltage	39
		vs Time	40
		vs Free-air temperature	41
I_{CC}	Supply current	vs Supply voltage	42, 43, 44
		vs Free-air temperature	45, 46, 47
SR	Slew rate	vs Load resistance	48–53
		vs Free-air temperature	54–59
	Overshoot factor	vs Load capacitance	60
V_n	Equivalent input noise voltage	vs Frequency	61, 62
THD	Total harmonic distortion	vs Frequency	63
B_1	Unity-gain bandwidth	vs Supply voltage	64, 65, 66
		vs Free-air temperature	67, 68, 69
ϕ_m	Phase margin	vs Supply voltage	70, 71, 72
		vs Load capacitance	73, 74, 75
		vs Free-air temperature	76, 77, 78
	Phase shift	vs Frequency	30
	Voltage-follower small-signal pulse response	vs Time	79
	Voltage-follower large-signal pulse response	vs Time	80



TYPICAL CHARACTERISTICS

**DISTRIBUTION OF TL051
 INPUT OFFSET VOLTAGE**

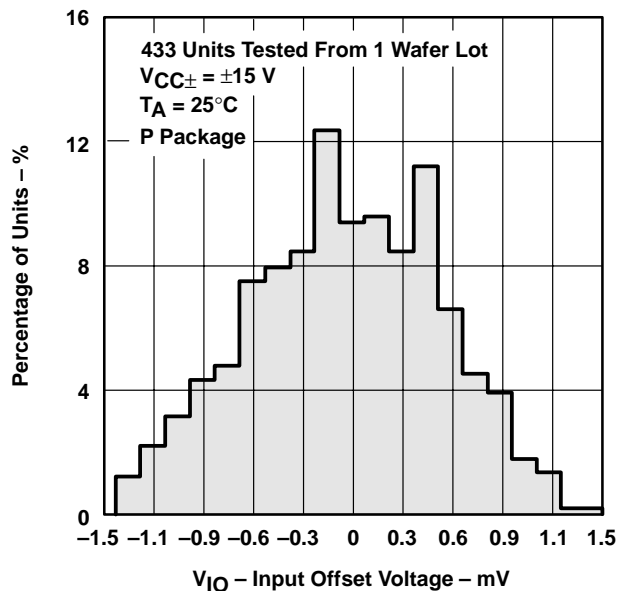

Figure 6

**DISTRIBUTION OF TL051A
 INPUT OFFSET VOLTAGE**

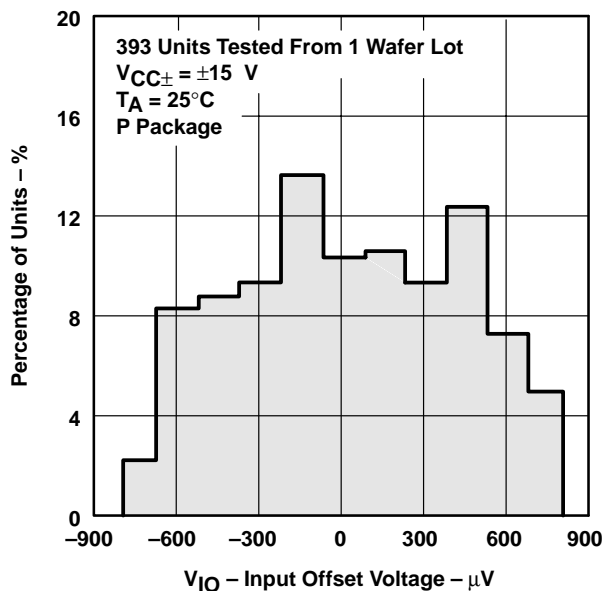

Figure 7

**DISTRIBUTION OF TL052
 INPUT OFFSET VOLTAGE**

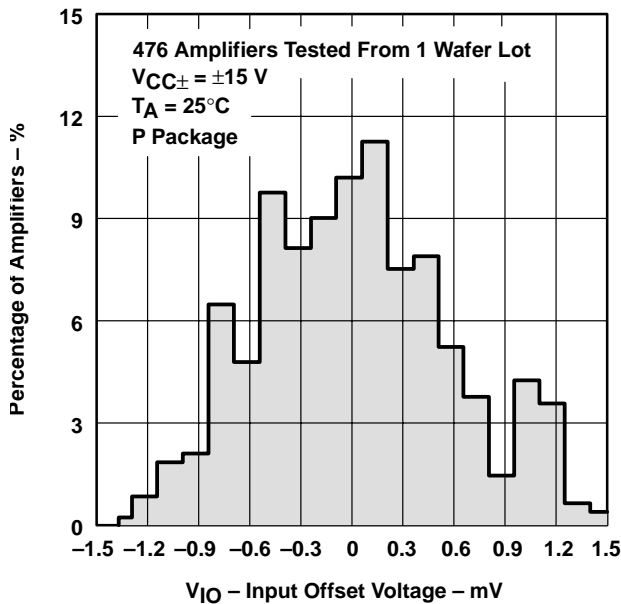

Figure 8

**DISTRIBUTION OF TL052A
 INPUT OFFSET VOLTAGE**

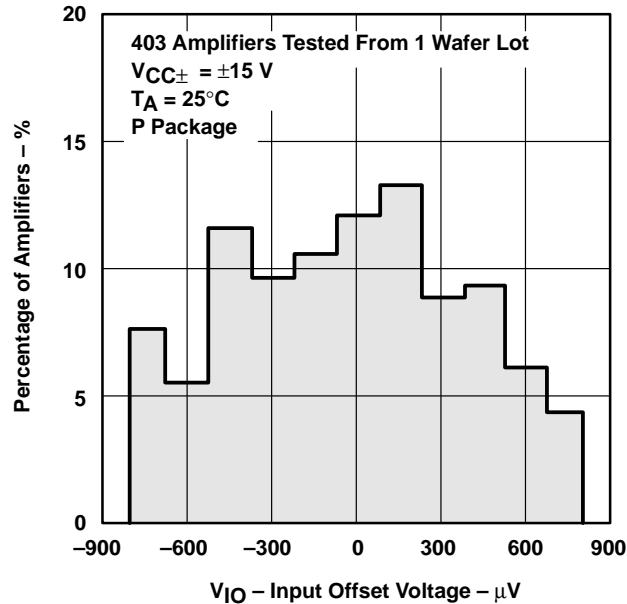

Figure 9

TL05x, TL05xA
ENHANCED-JFET LOW-OFFSET
OPERATIONAL AMPLIFIERS

SLOS178A – FEBRUARY 1997 - REVISED FEBRUARY 2003

TYPICAL CHARACTERISTICS

DISTRIBUTION OF TL054
INPUT OFFSET VOLTAGE

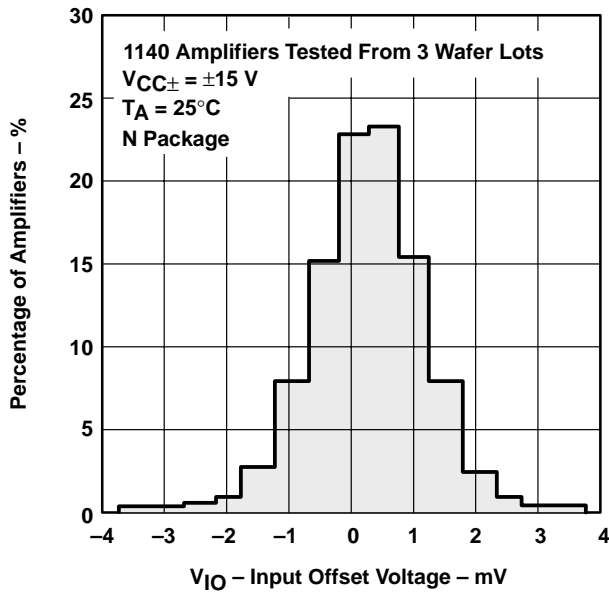

Figure 10

DISTRIBUTION OF TL054A
INPUT OFFSET VOLTAGE

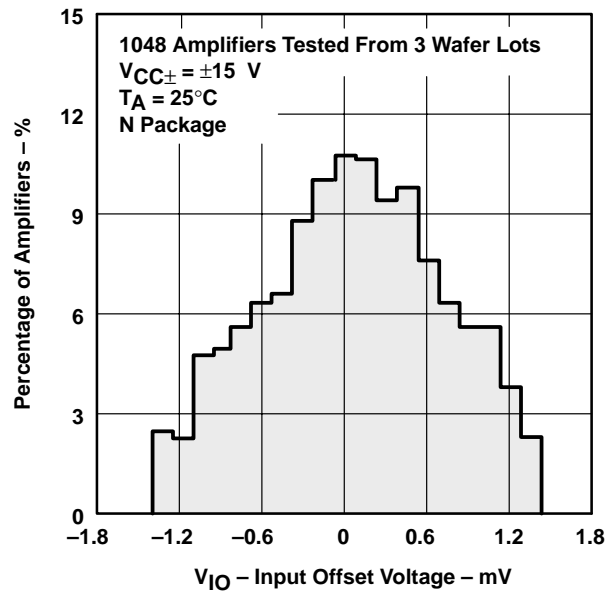

Figure 11

DISTRIBUTION OF TL051
INPUT OFFSET VOLTAGE
TEMPERATURE COEFFICIENT

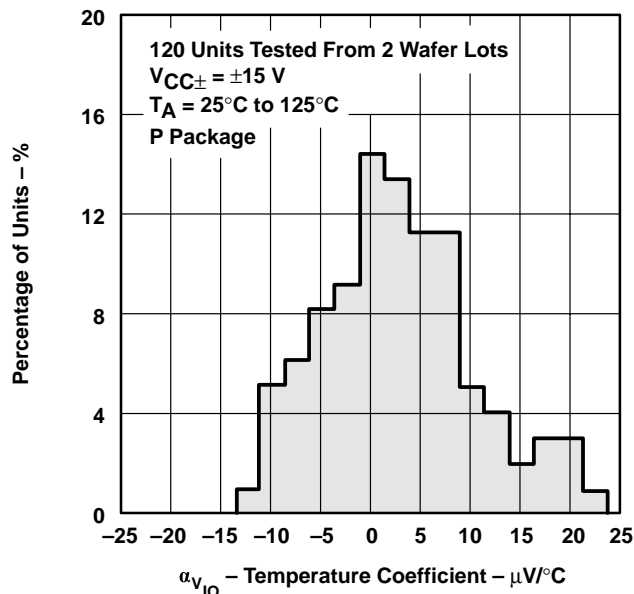

Figure 12

DISTRIBUTION OF TL052
INPUT OFFSET VOLTAGE
TEMPERATURE COEFFICIENT

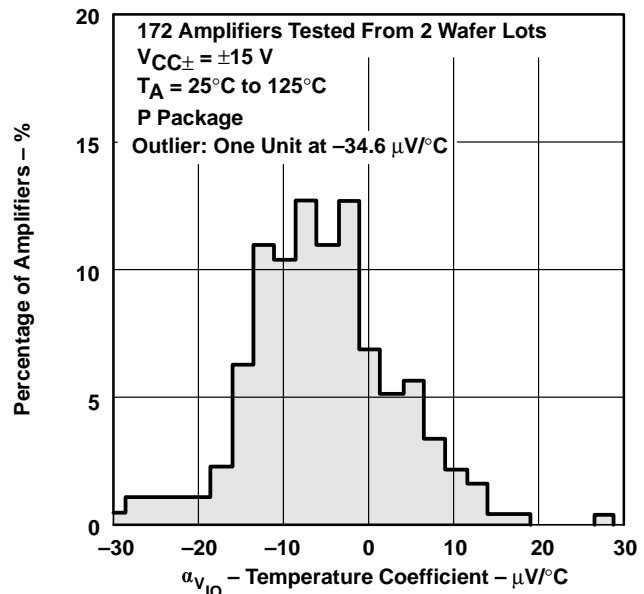

Figure 13

TYPICAL CHARACTERISTICS

**DISTRIBUTION OF TL054
 INPUT OFFSET VOLTAGE
 TEMPERATURE COEFFICIENT**

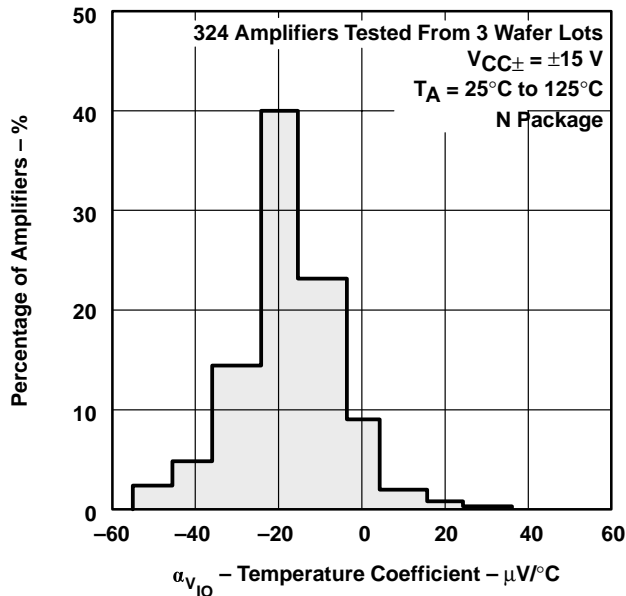

Figure 14

**INPUT BIAS CURRENT
 vs
 COMMON-MODE INPUT VOLTAGE**

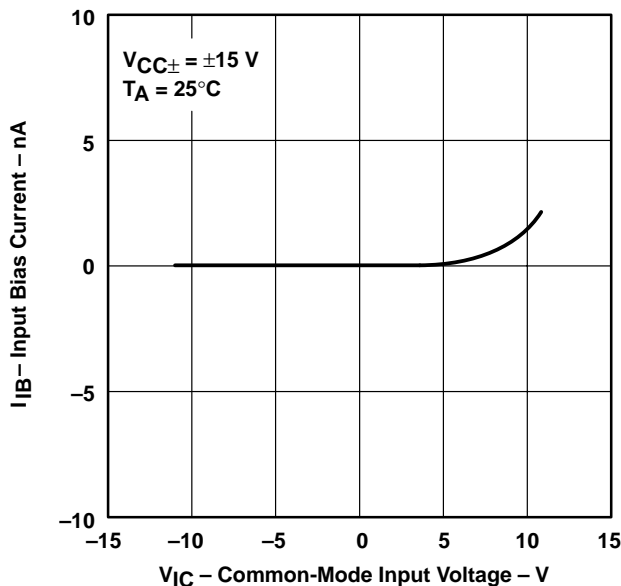

Figure 15

**INPUT BIAS CURRENT AND
 INPUT OFFSET CURRENT†
 vs
 FREE-AIR TEMPERATURE**

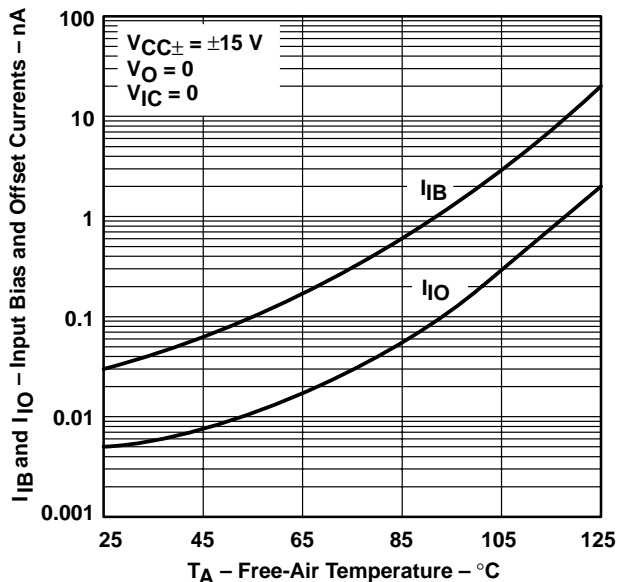

Figure 16

**COMMON-MODE
 INPUT VOLTAGE RANGE LIMITS
 vs
 SUPPLY VOLTAGE**

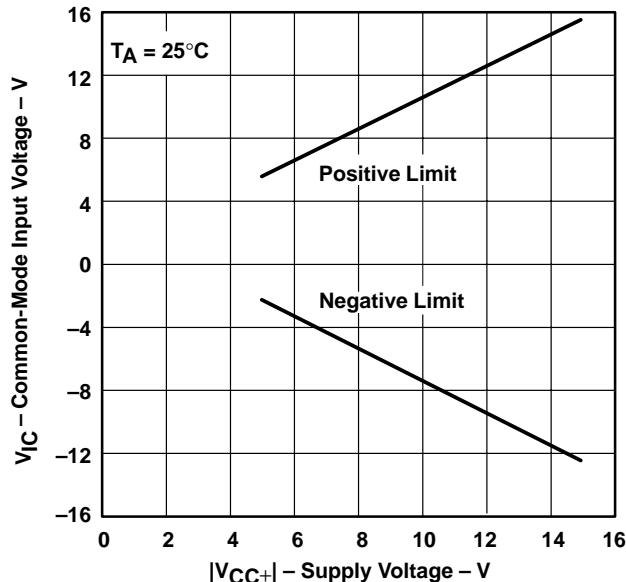

Figure 17

† Data at high and low temperatures are applicable only within the rated operating free-air temperature ranges of the various devices.

TL05x, TL05xA
ENHANCED-JFET LOW-OFFSET
OPERATIONAL AMPLIFIERS

SLOS178A – FEBRUARY 1997 - REVISED FEBRUARY 2003

TYPICAL CHARACTERISTICS

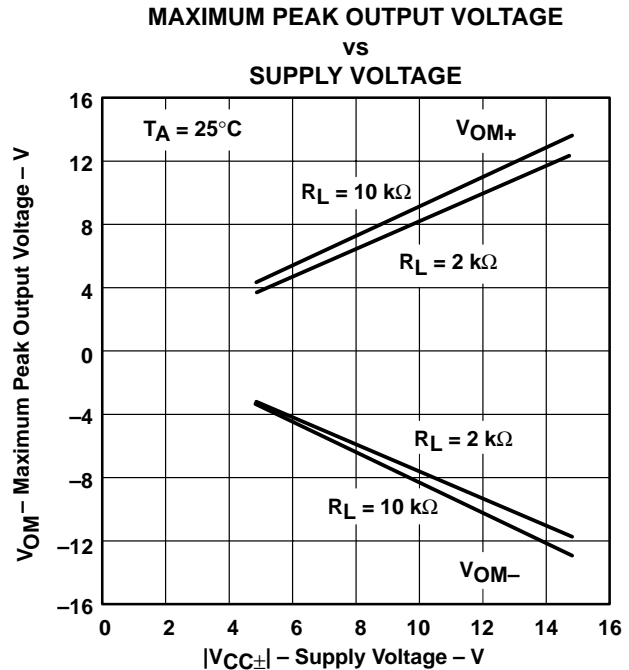
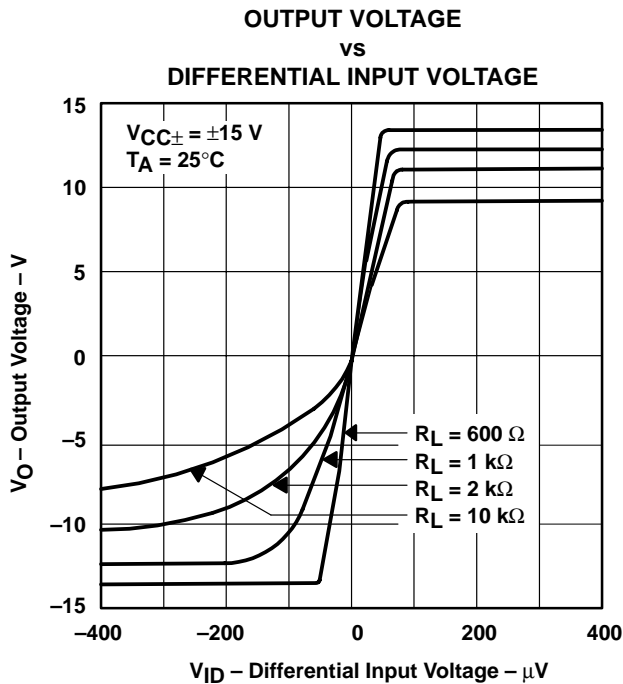
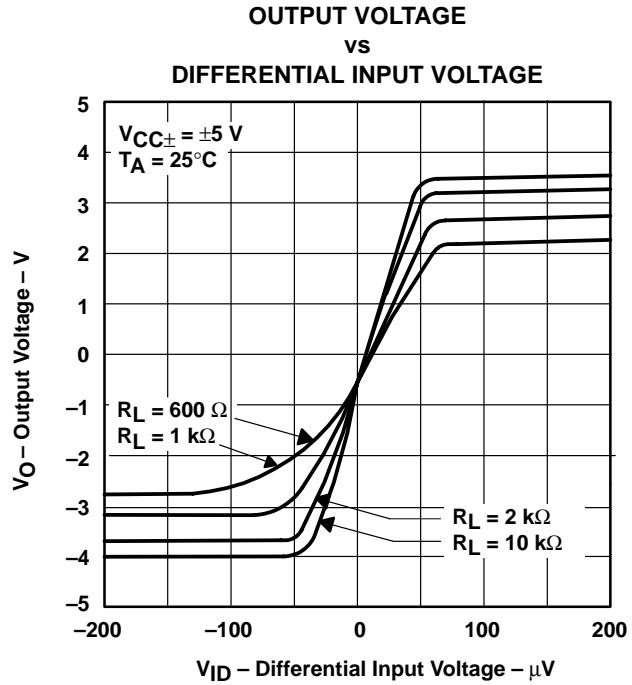
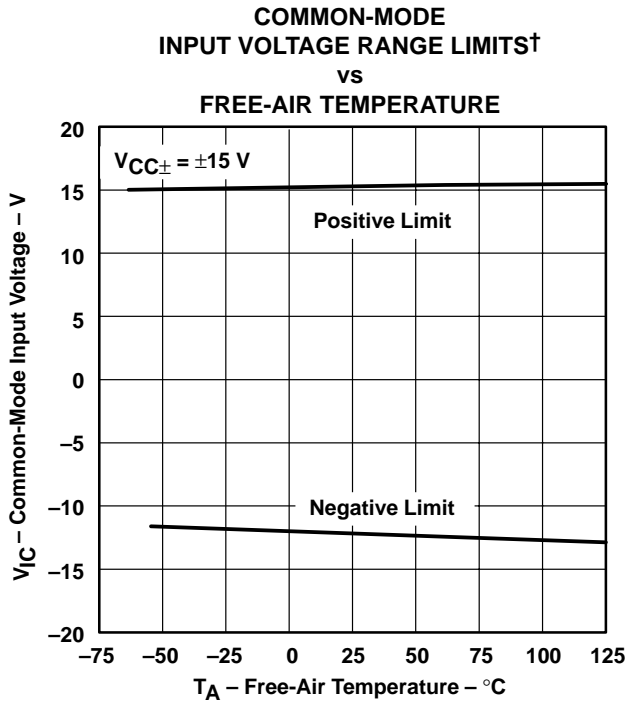

† Data at high and low temperatures are applicable only within the rated operating free-air temperature ranges of the various devices.



TYPICAL CHARACTERISTICS

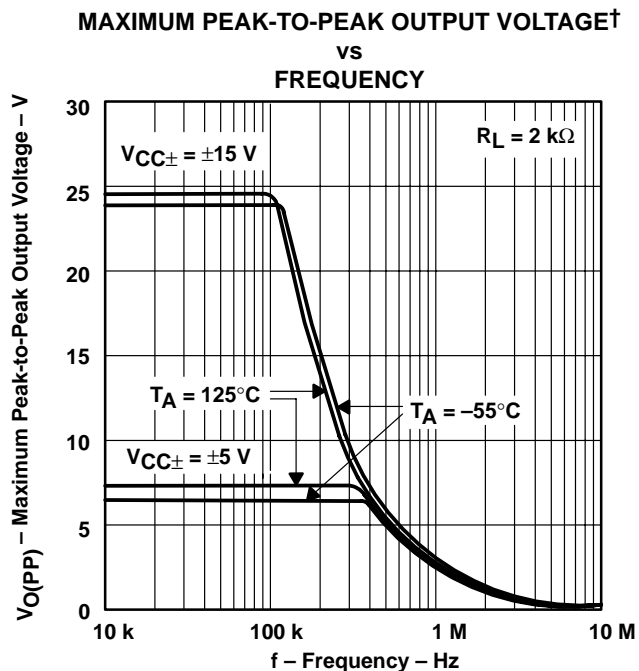

Figure 22

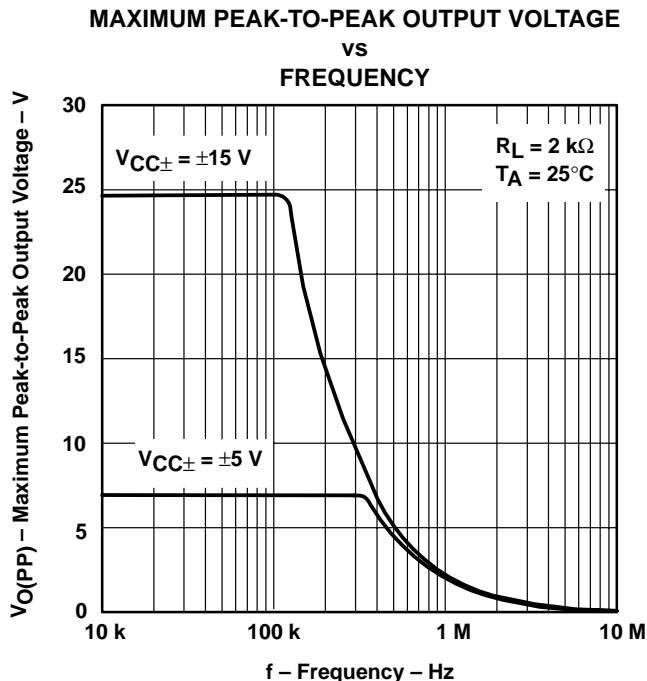

Figure 23

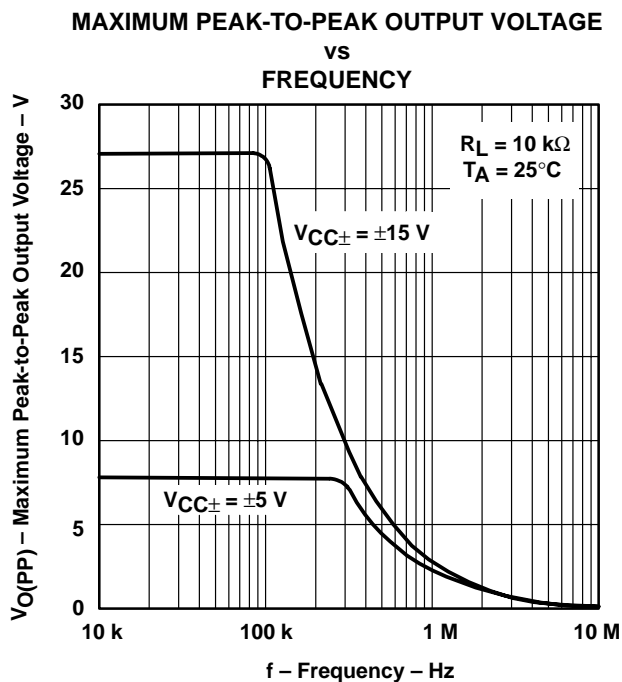

Figure 24

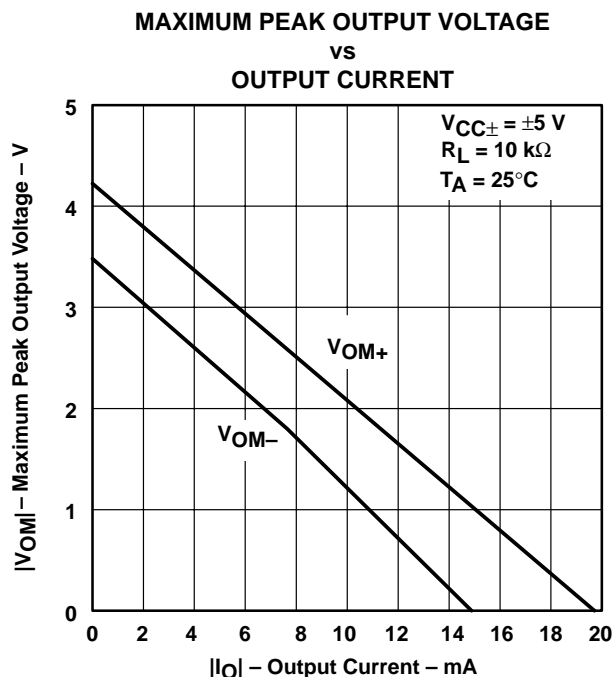

Figure 25

† Data at high and low temperatures are applicable only within the rated operating free-air temperature ranges of the various devices.

TL05x, TL05xA ENHANCED-JFET LOW-OFFSET OPERATIONAL AMPLIFIERS

SLOS178A – FEBRUARY 1997 - REVISED FEBRUARY 2003

TYPICAL CHARACTERISTICS

MAXIMUM PEAK OUTPUT VOLTAGE
vs
OUTPUT CURRENT

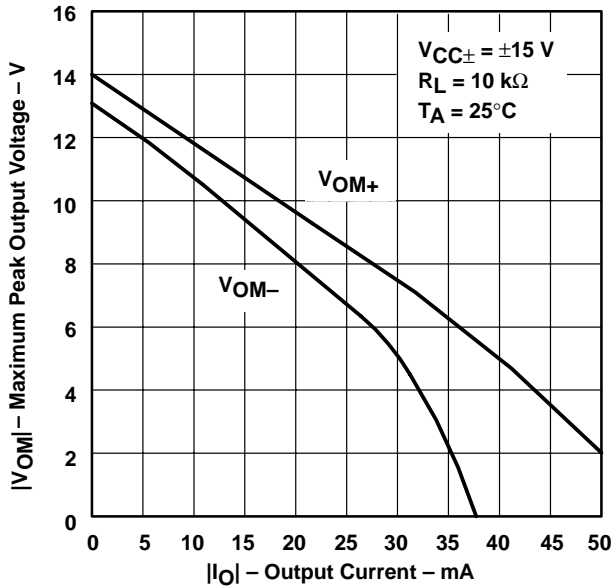

Figure 26

MAXIMUM PEAK OUTPUT VOLTAGE†
vs
FREE-AIR TEMPERATURE

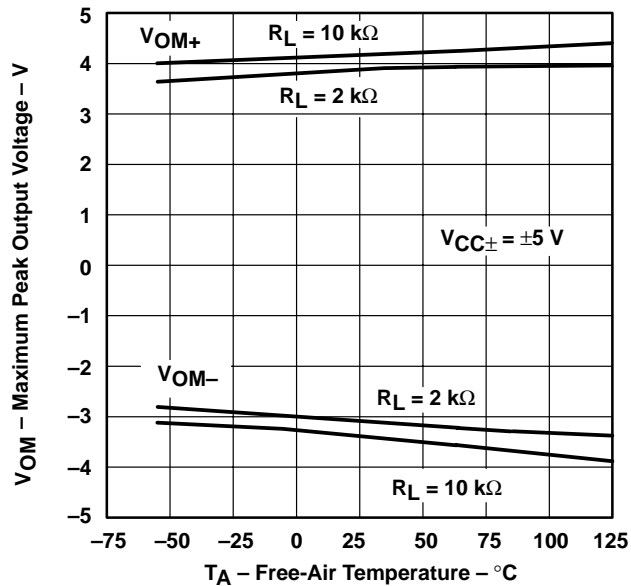

Figure 27

MAXIMUM PEAK OUTPUT VOLTAGE†
vs
FREE-AIR TEMPERATURE

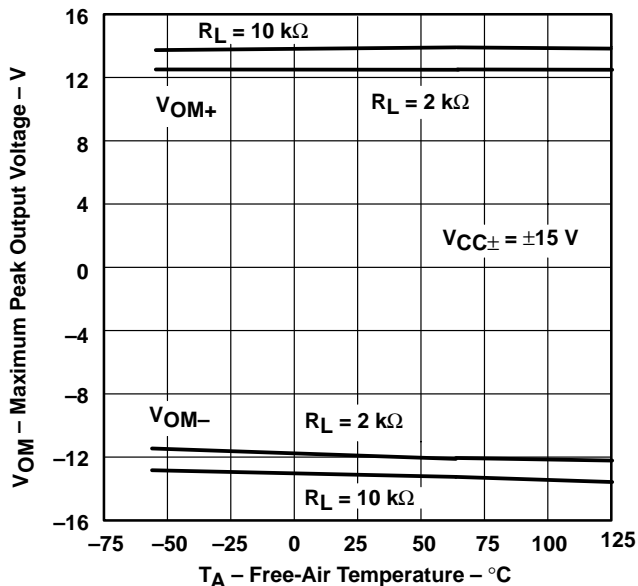

Figure 28

LARGE-SIGNAL DIFFERENTIAL VOLTAGE
AMPLIFICATION
vs
LOAD RESISTANCE

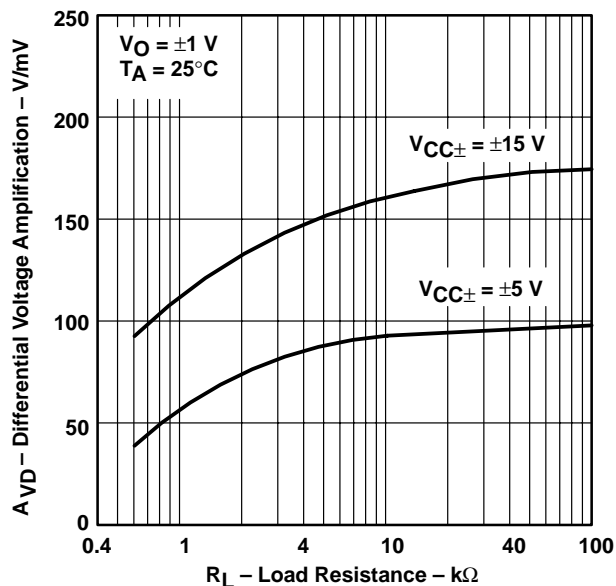

Figure 29

† Data at high and low temperatures are applicable only within the rated operating free-air temperature ranges of the various devices.



**TYPICAL CHARACTERISTICS
 LARGE-SIGNAL DIFFERENTIAL VOLTAGE
 AMPLIFICATION AND PHASE SHIFT
 vs
 FREQUENCY**

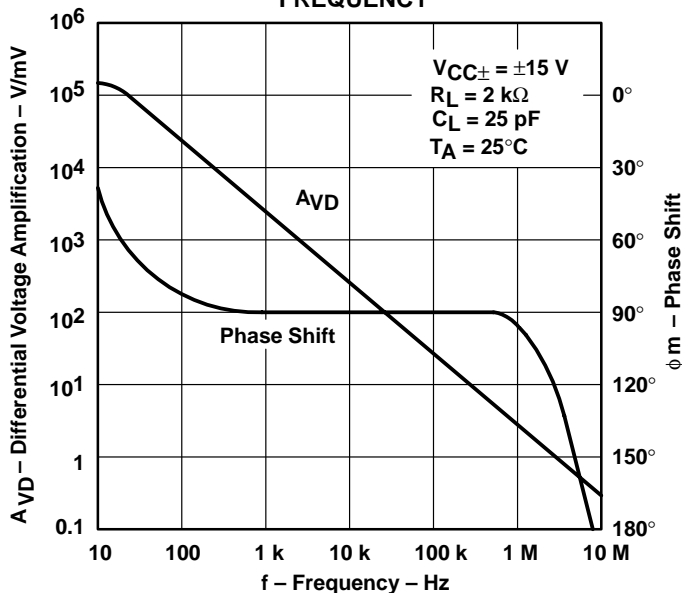

Figure 30

**TL051 AND TL052
 LARGE-SIGNAL DIFFERENTIAL
 VOLTAGE AMPLIFICATION†
 vs
 FREE-AIR TEMPERATURE**

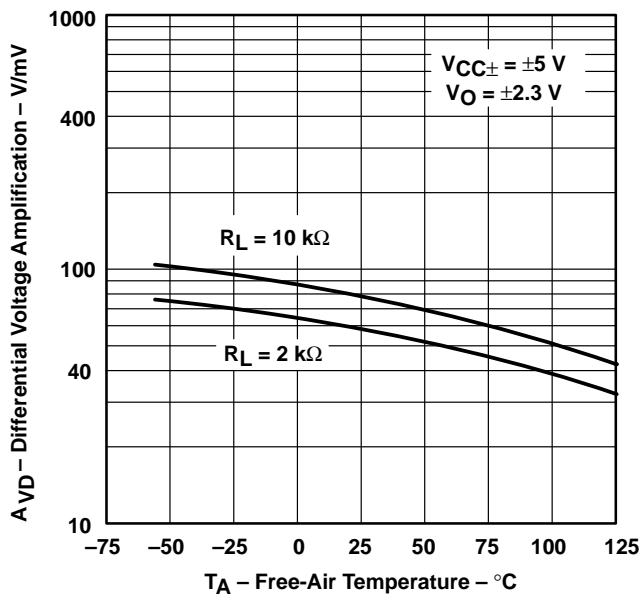

Figure 31

**TL054
 LARGE-SIGNAL DIFFERENTIAL
 VOLTAGE AMPLIFICATION†
 vs
 FREE-AIR TEMPERATURE**

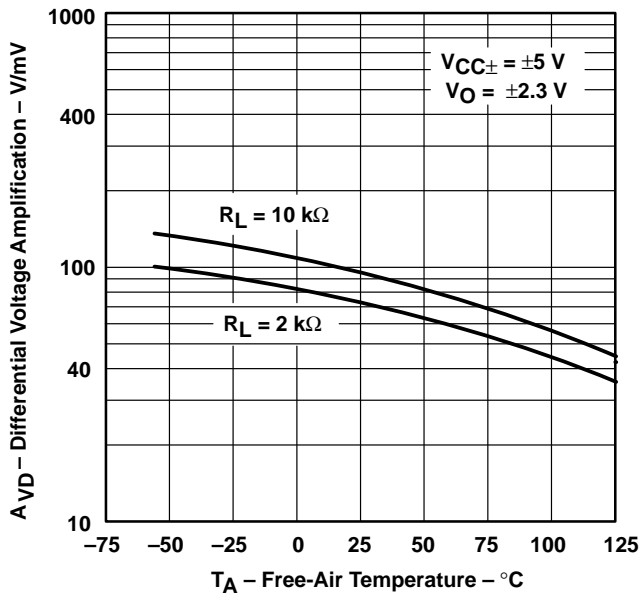

Figure 32

† Data at high and low temperatures are applicable only within the rated operating free-air temperature ranges of the various devices.

TL05x, TL05xA ENHANCED-JFET LOW-OFFSET OPERATIONAL AMPLIFIERS

SLOS178A – FEBRUARY 1997 - REVISED FEBRUARY 2003

TYPICAL CHARACTERISTICS

LARGE-SIGNAL DIFFERENTIAL VOLTAGE
AMPLIFICATION†
vs
FREE-AIR TEMPERATURE

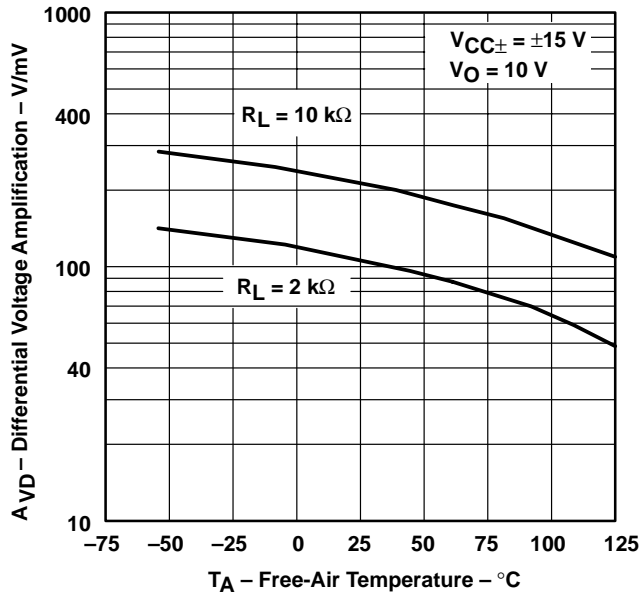

Figure 33

COMMON-MODE REJECTION RATIO
vs
FREQUENCY

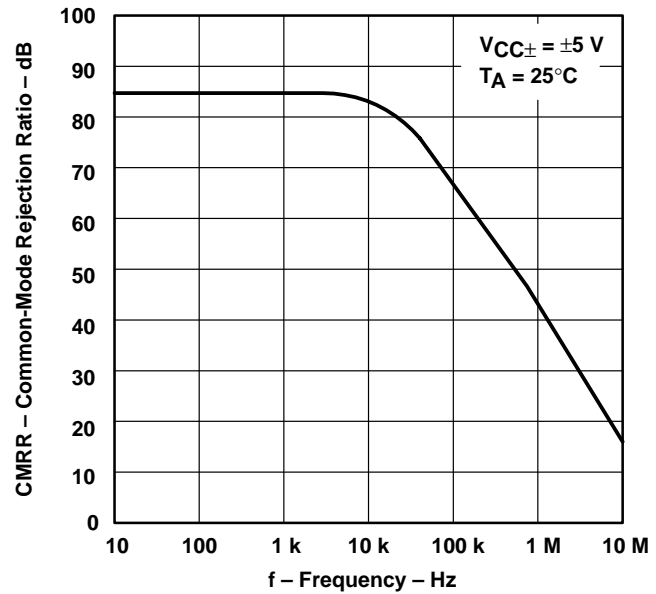

Figure 34

COMMON-MODE REJECTION RATIO
vs
FREQUENCY

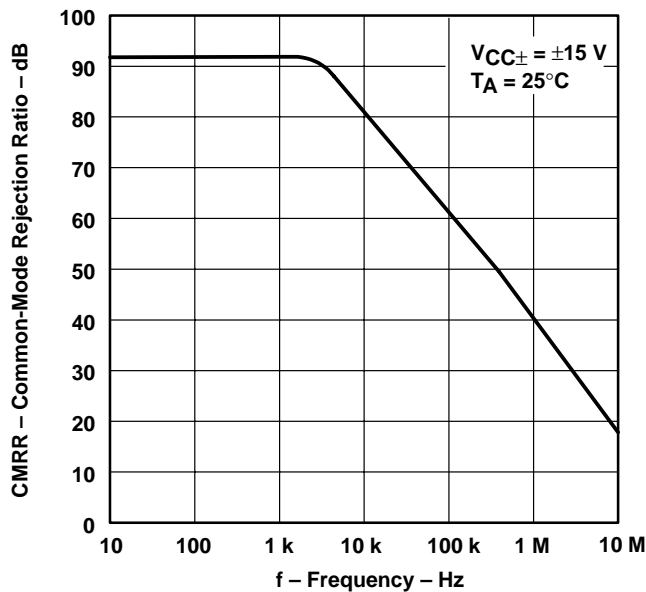

Figure 35

COMMON-MODE REJECTION RATIO†
vs
FREE-AIR TEMPERATURE

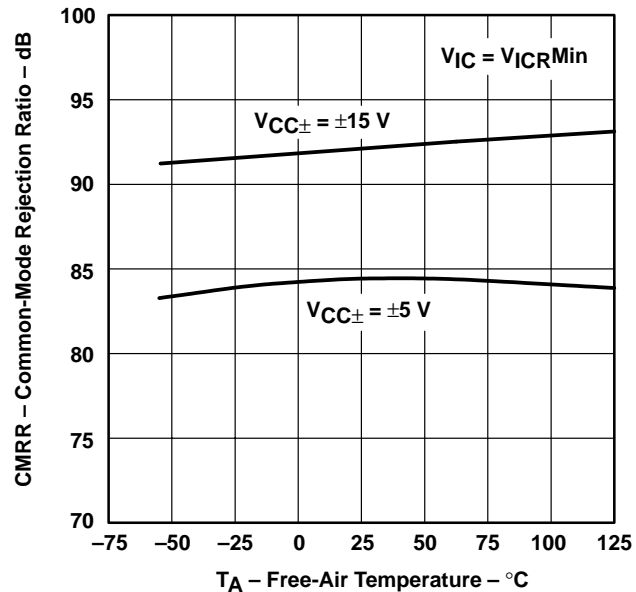

Figure 36

† Data at high and low temperatures are applicable only within the rated operating free-air temperature ranges of the various devices.

TYPICAL CHARACTERISTICS

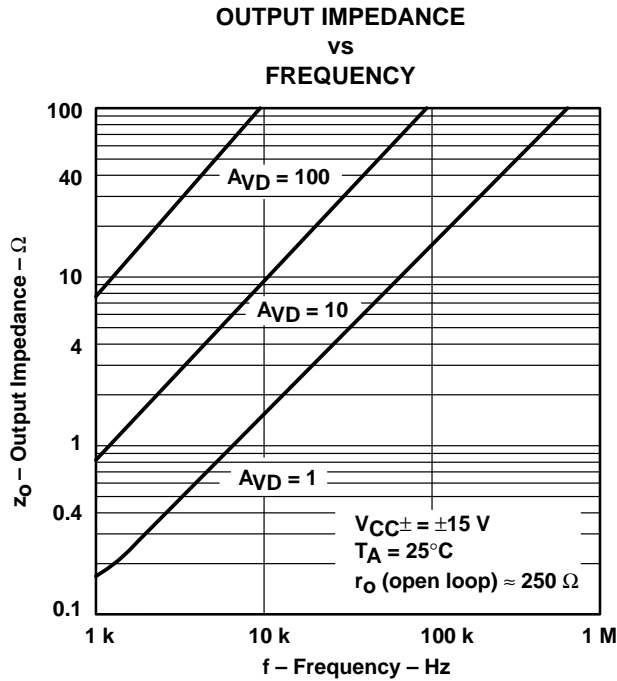

Figure 37

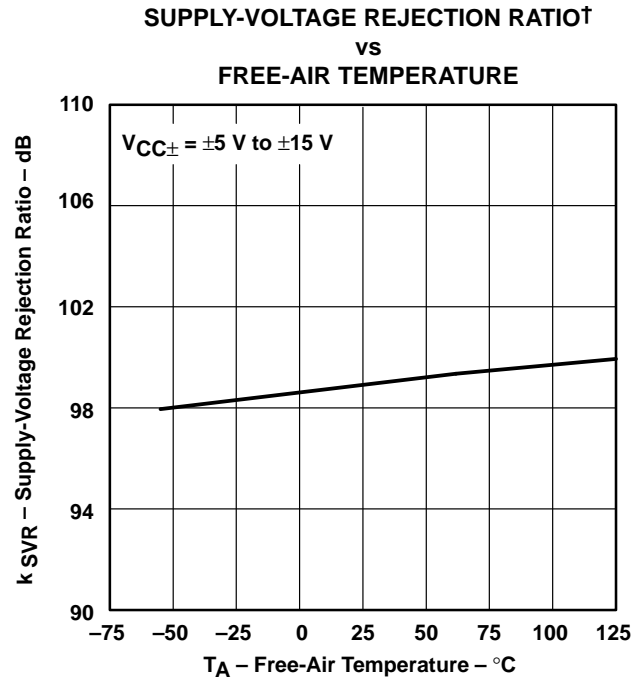

Figure 38

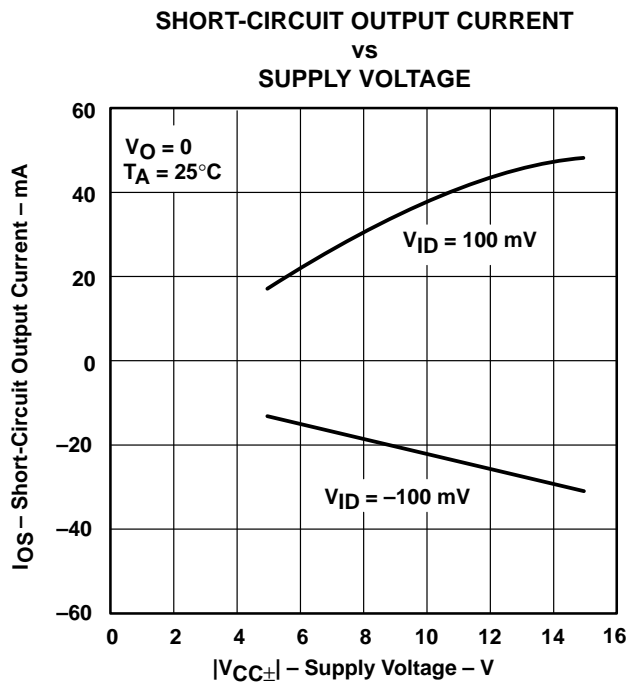

Figure 39

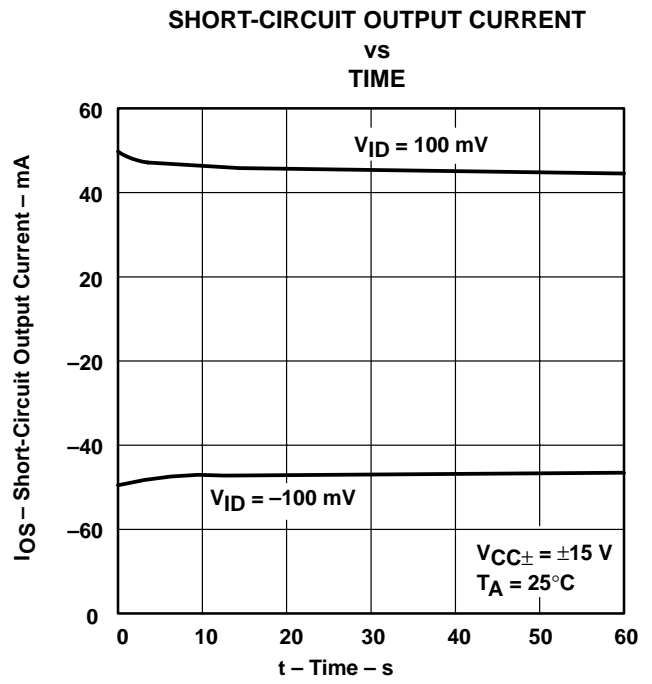

Figure 40

† Data at high and low temperatures are applicable only within the rated operating free-air temperature ranges of the various devices.

TL05x, TL05xA
ENHANCED-JFET LOW-OFFSET
OPERATIONAL AMPLIFIERS

SLOS178A – FEBRUARY 1997 - REVISED FEBRUARY 2003

TYPICAL CHARACTERISTICS

SHORT-CIRCUIT OUTPUT CURRENT†
vs
FREE-AIR TEMPERATURE

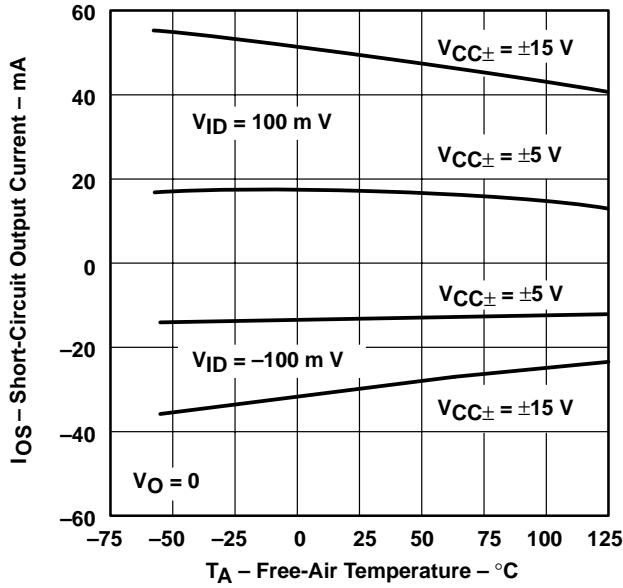

Figure 41

TL051
SUPPLY CURRENT†
vs
SUPPLY VOLTAGE

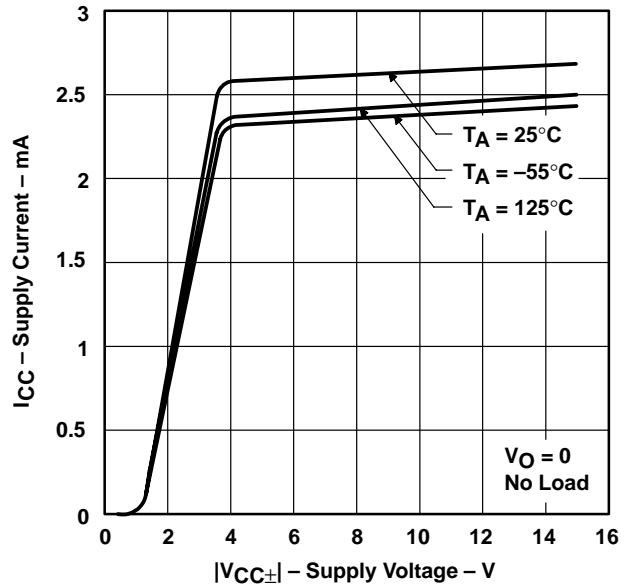

Figure 42

TL052
SUPPLY CURRENT†
vs
SUPPLY VOLTAGE

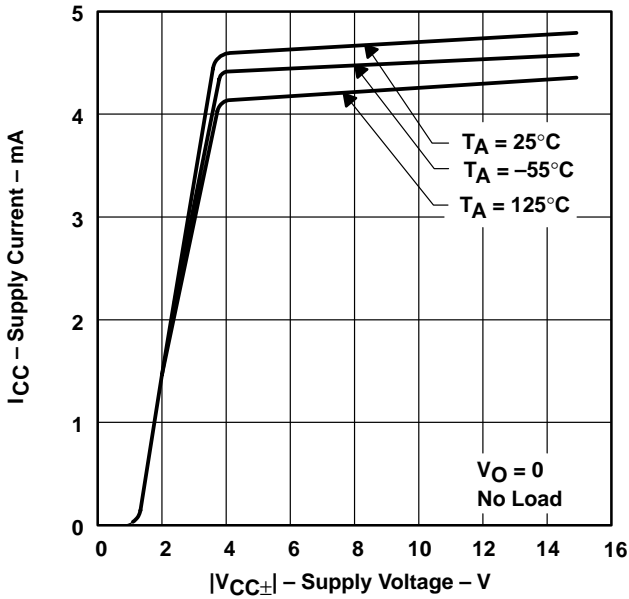

Figure 43

TL054
SUPPLY CURRENT†
vs
SUPPLY VOLTAGE

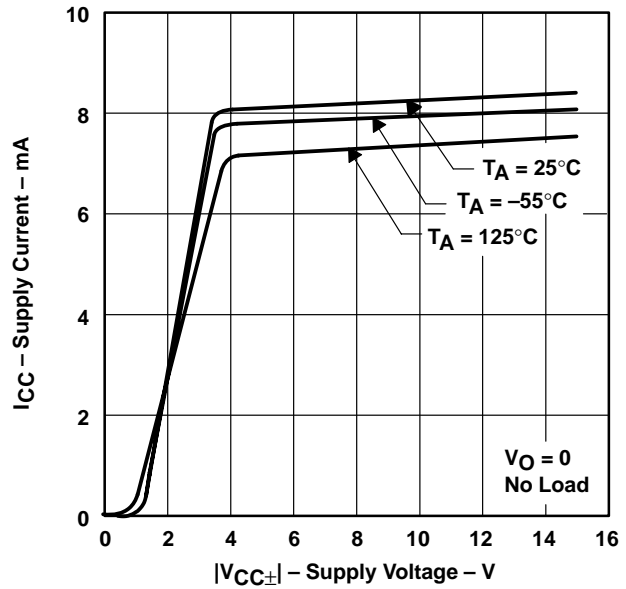

Figure 44

† Data at high and low temperatures are applicable only within the rated operating free-air temperature ranges of the various devices.



TYPICAL CHARACTERISTICS

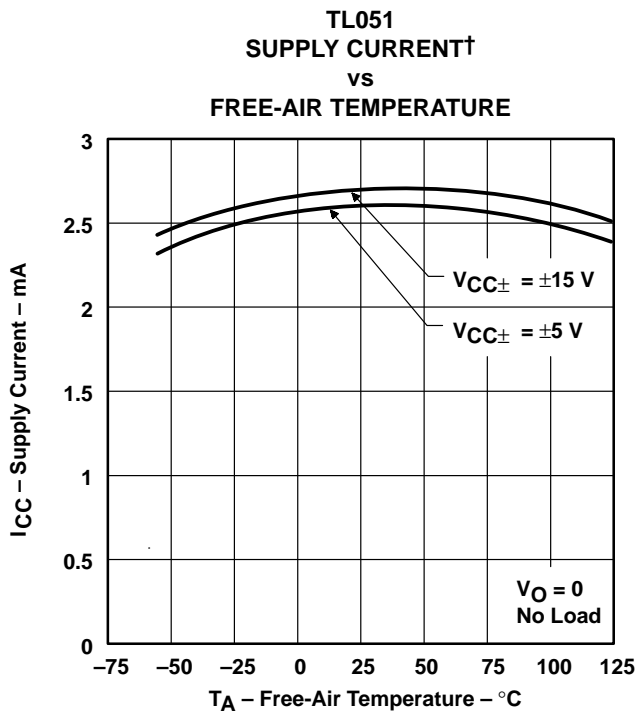

Figure 45

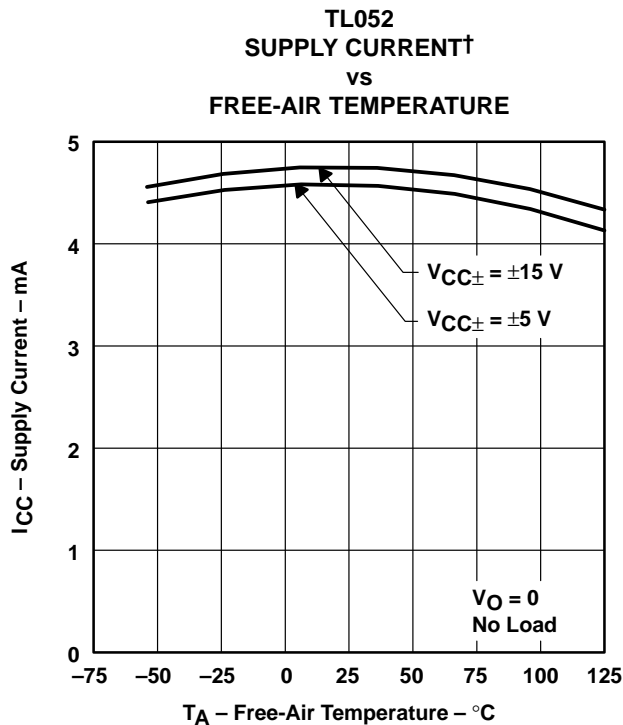

Figure 46

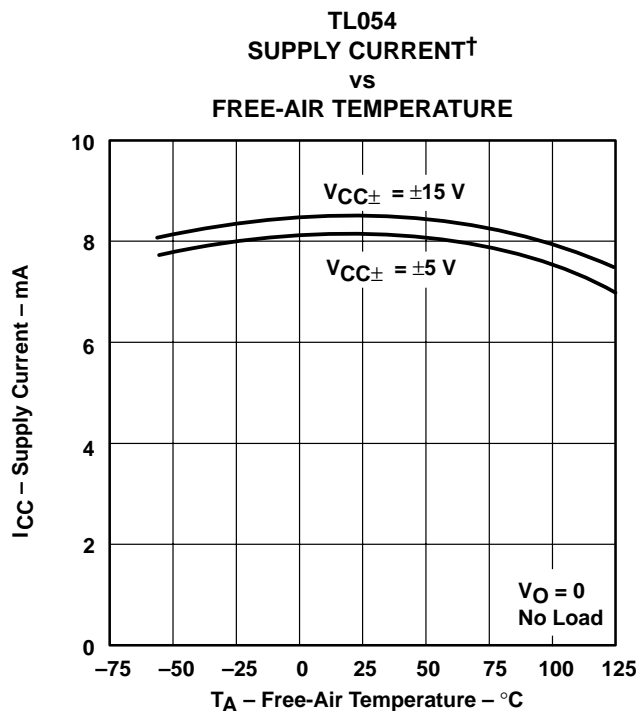

Figure 47

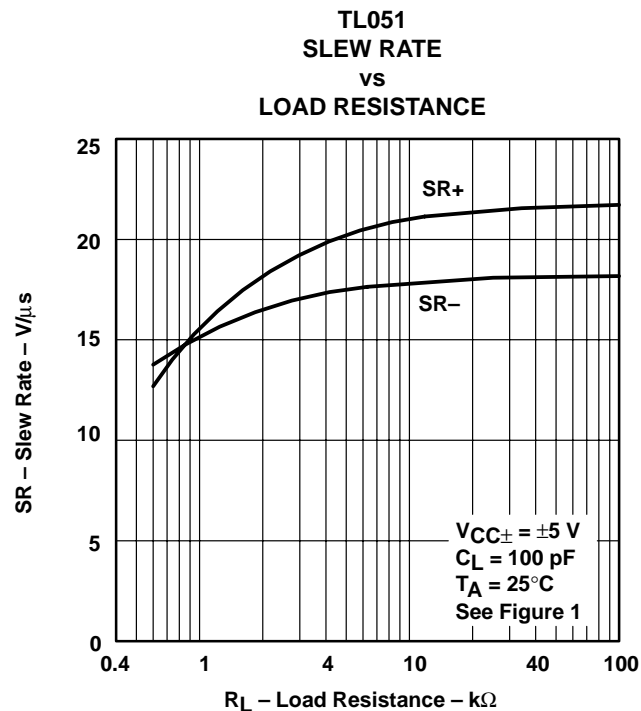

Figure 48

† Data at high and low temperatures are applicable only within the rated operating free-air temperature ranges of the various devices.

TL05x, TL05xA
ENHANCED-JFET LOW-OFFSET
OPERATIONAL AMPLIFIERS

SLOS178A – FEBRUARY 1997 - REVISED FEBRUARY 2003

TYPICAL CHARACTERISTICS

TL052
SLEW RATE
vs
LOAD RESISTANCE

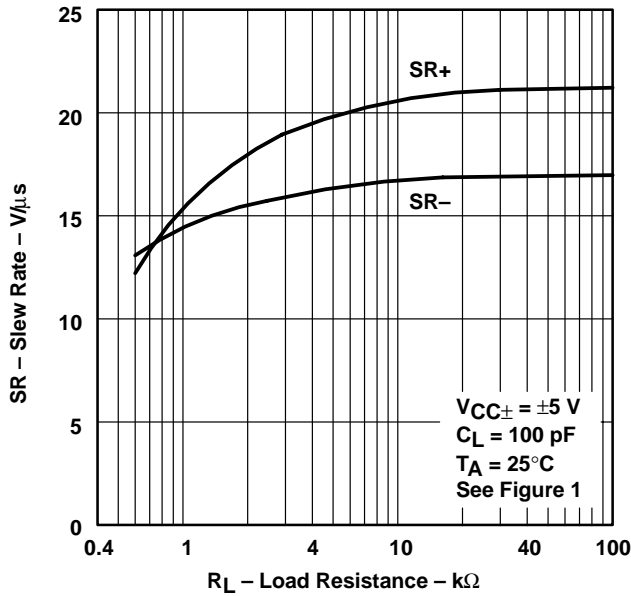

Figure 49

TL054
SLEW RATE
vs
LOAD RESISTANCE

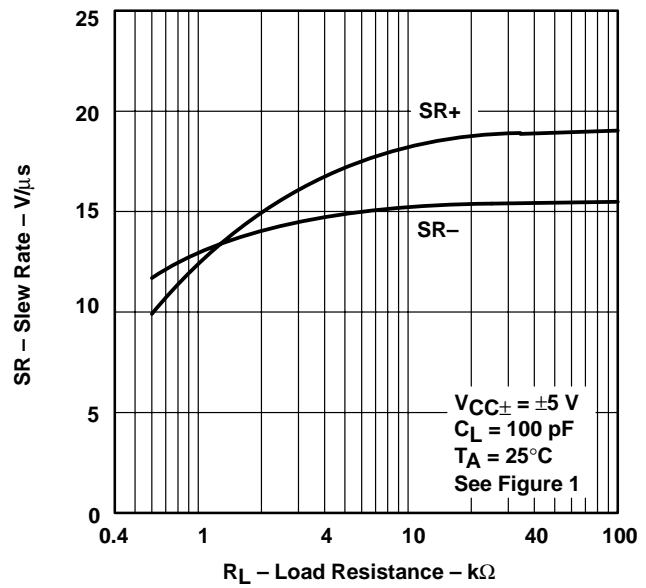

Figure 50

TL051
SLEW RATE
vs
LOAD RESISTANCE

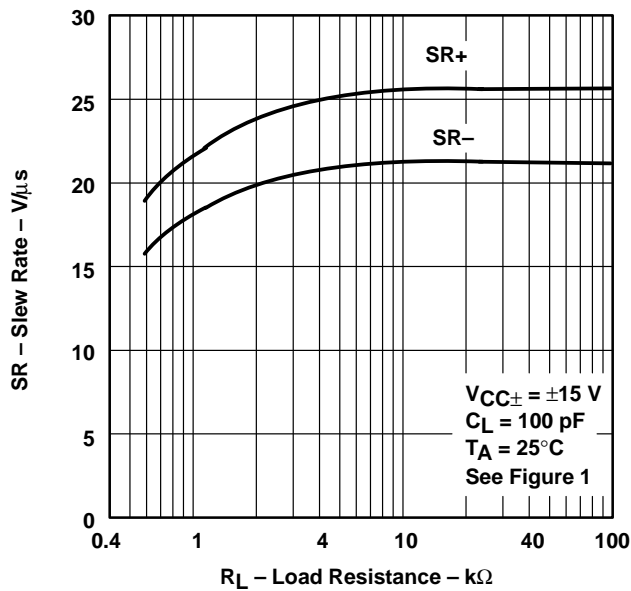

Figure 51

TL052
SLEW RATE
vs
LOAD RESISTANCE

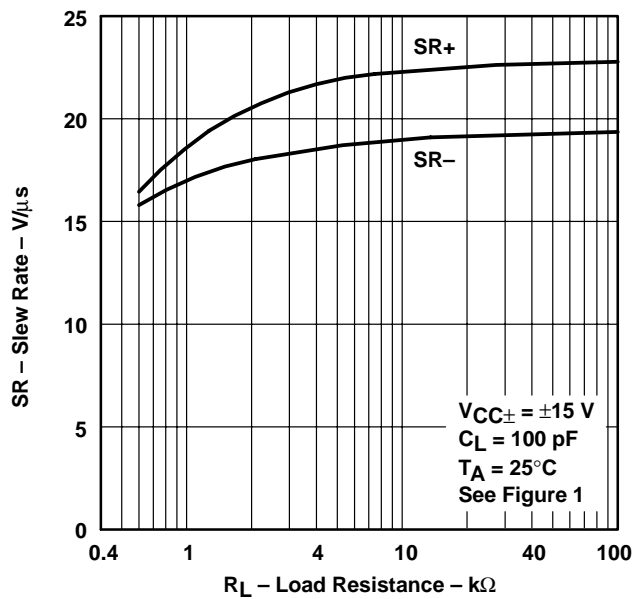
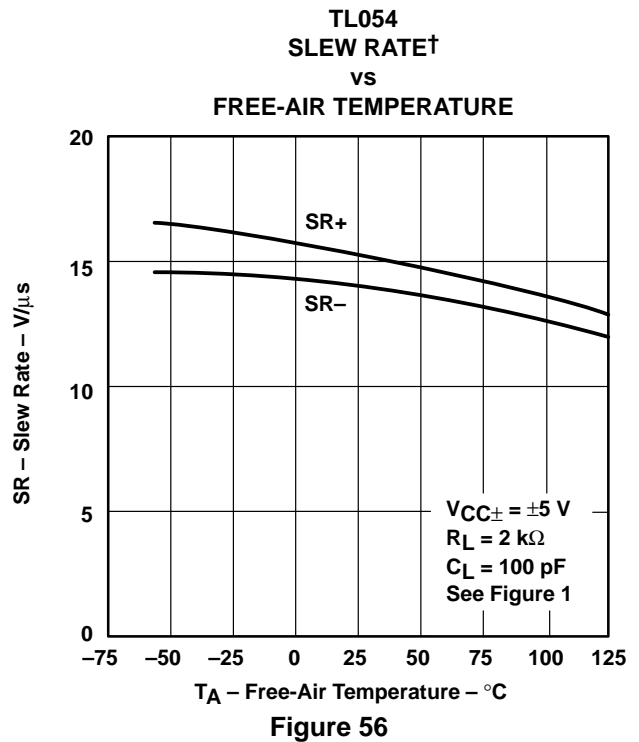
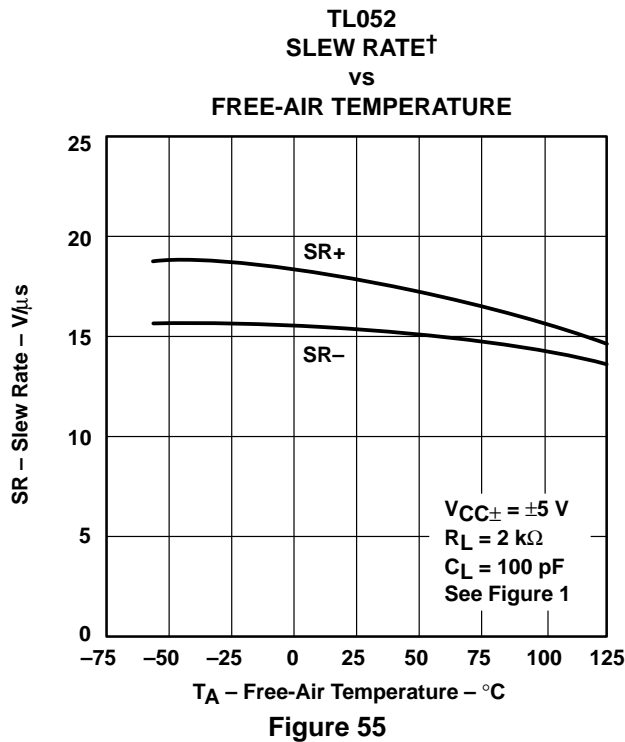
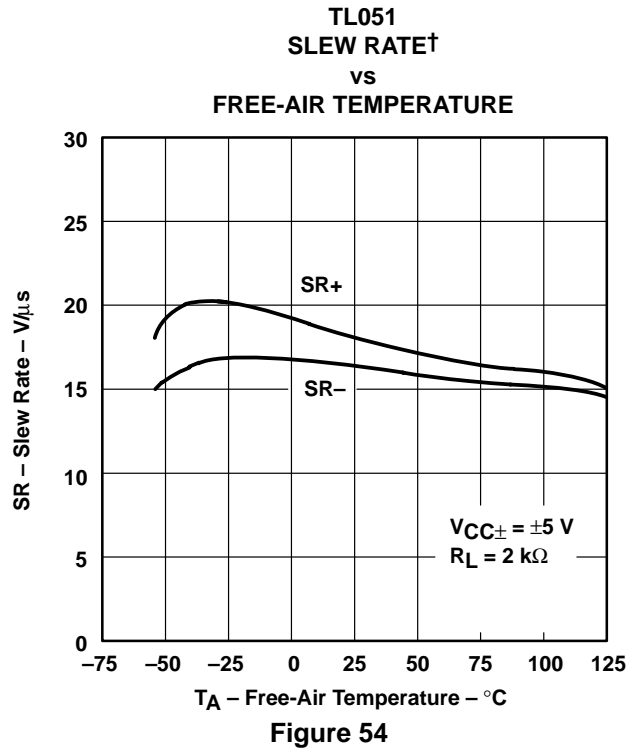
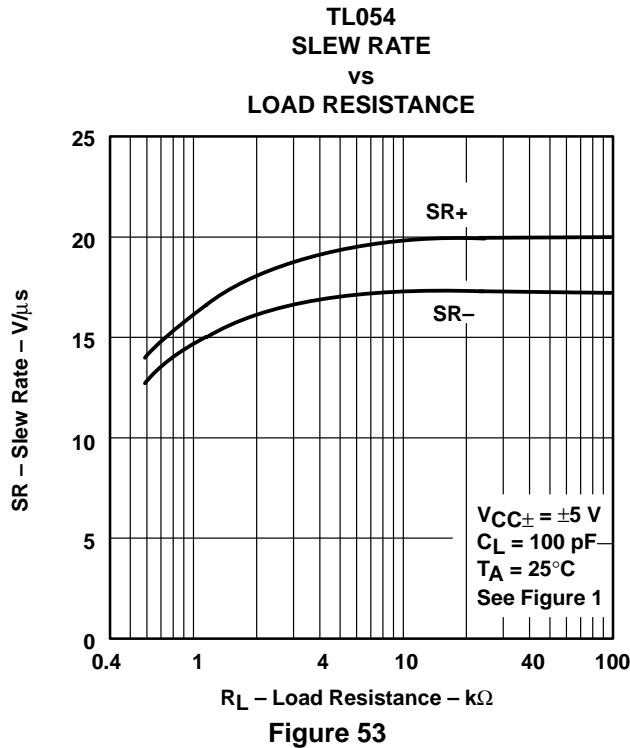

Figure 52



TYPICAL CHARACTERISTICS



† Data at high and low temperatures are applicable only within the rated operating free-air temperature ranges of the various devices.

TL05x, TL05xA
ENHANCED-JFET LOW-OFFSET
OPERATIONAL AMPLIFIERS

SLOS178A – FEBRUARY 1997 - REVISED FEBRUARY 2003

TYPICAL CHARACTERISTICS

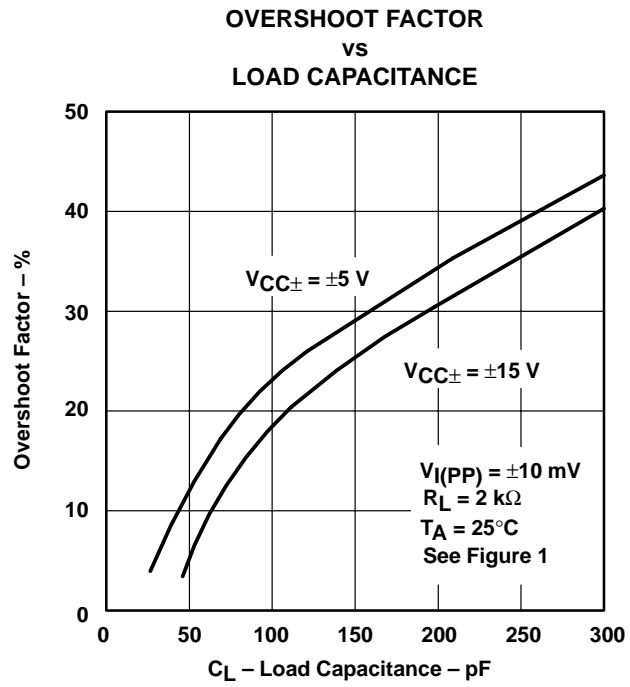
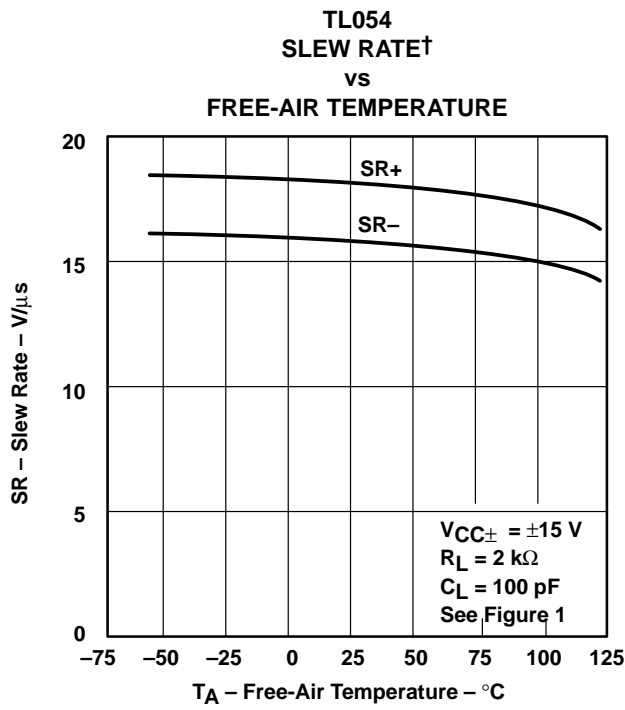
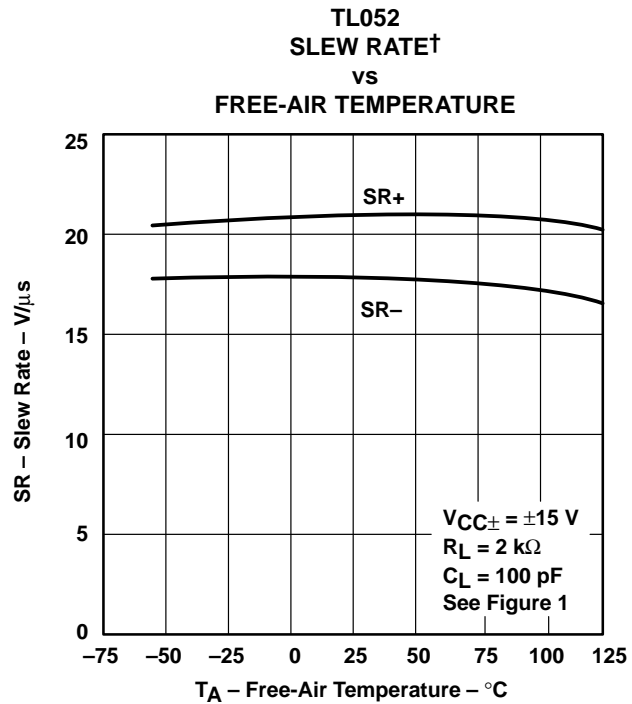
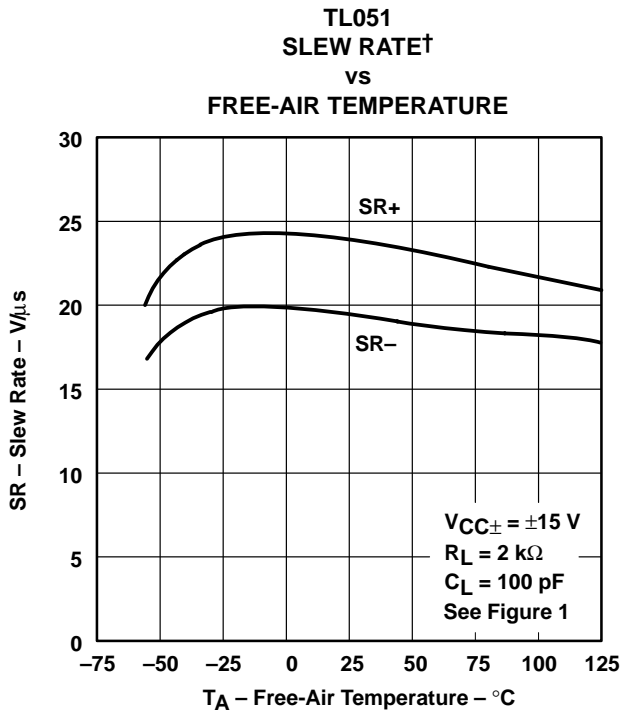

† Data at high and low temperatures are applicable only within the rated operating free-air temperature ranges of the various devices.



TYPICAL CHARACTERISTICS

TL051
 EQUIVALENT INPUT NOISE VOLTAGE
 VS
 FREQUENCY

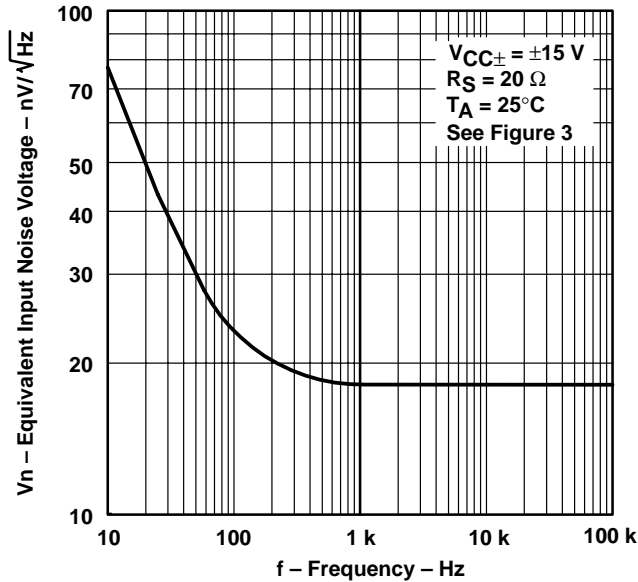

Figure 61

TL052 AND TL054
 EQUIVALENT INPUT NOISE VOLTAGE
 VS
 FREQUENCY

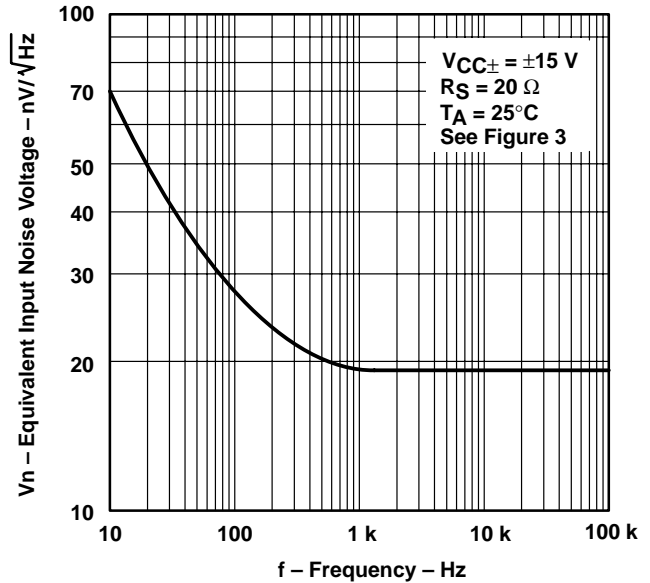

Figure 62

TOTAL HARMONIC DISTORTION
 VS
 FREQUENCY

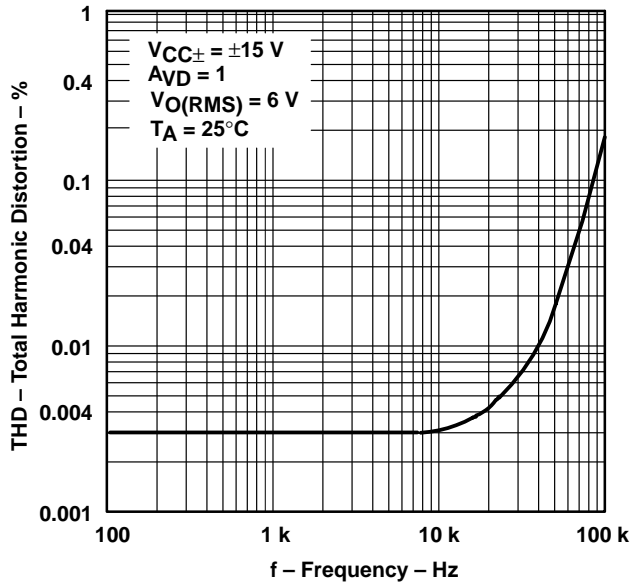

Figure 63

TL051
 UNITY-GAIN BANDWIDTH
 VS
 SUPPLY VOLTAGE

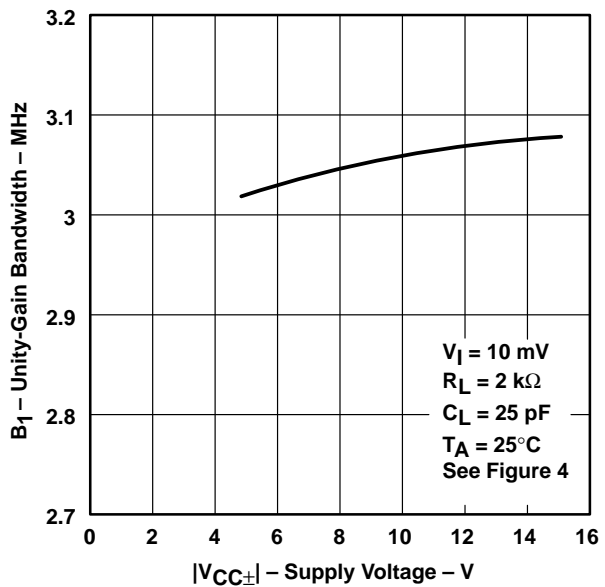
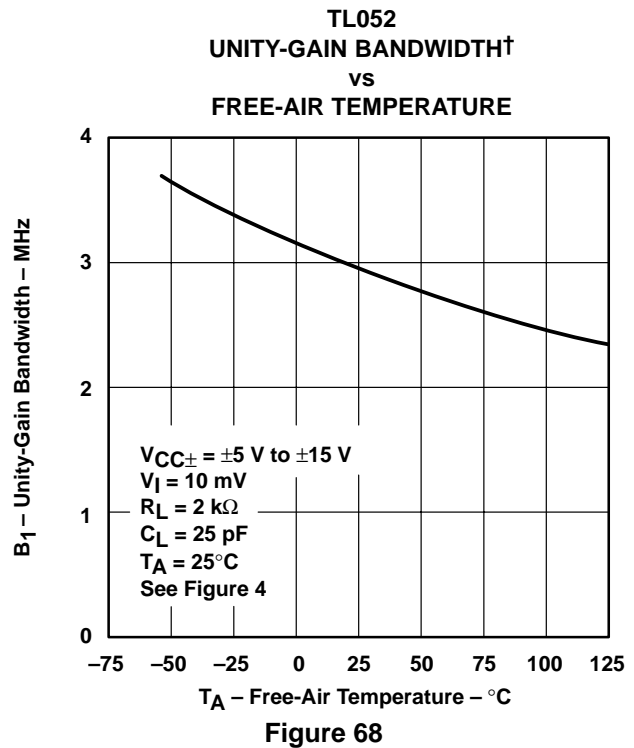
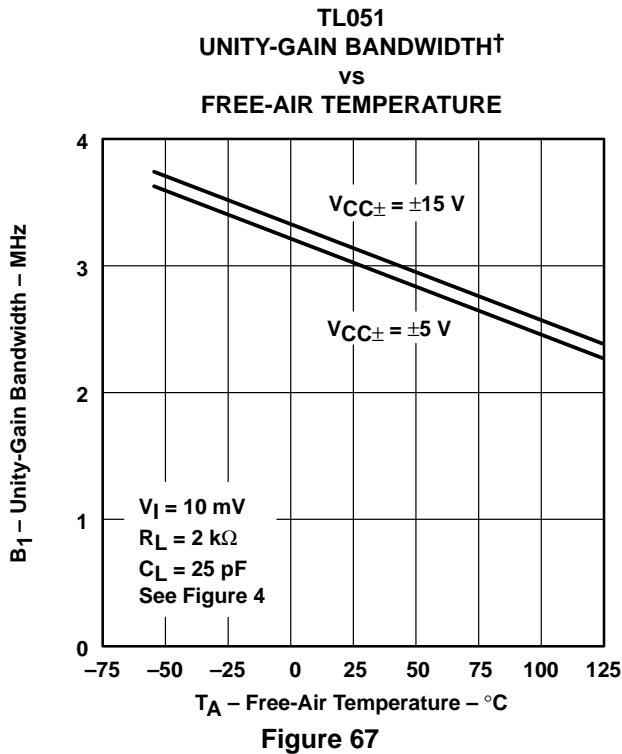
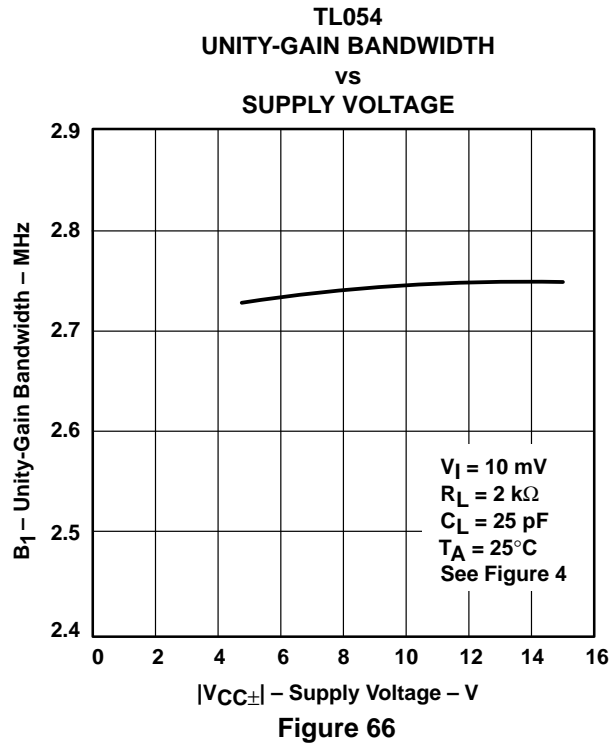
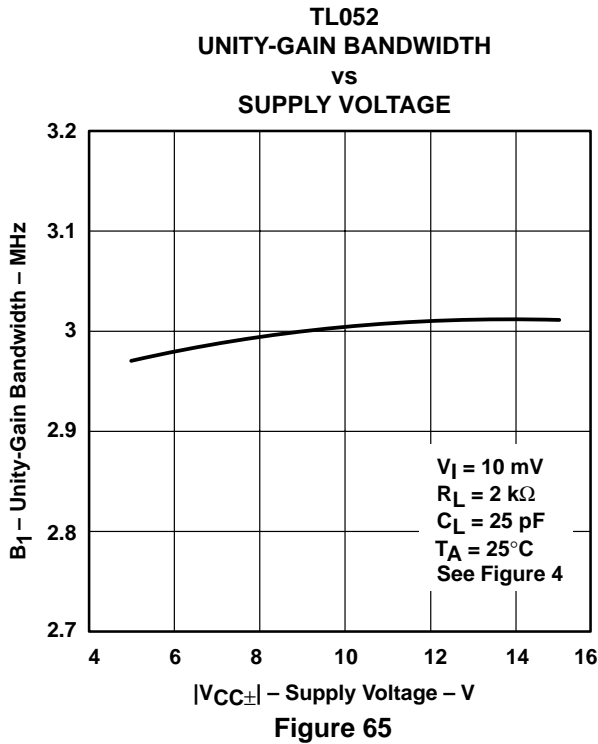

Figure 64

TL05x, TL05xA
ENHANCED-JFET LOW-OFFSET
OPERATIONAL AMPLIFIERS

SLOS178A – FEBRUARY 1997 - REVISED FEBRUARY 2003

TYPICAL CHARACTERISTICS



† Data at high and low temperatures are applicable only within the rated operating free-air temperature ranges of the various devices.



TYPICAL CHARACTERISTICS

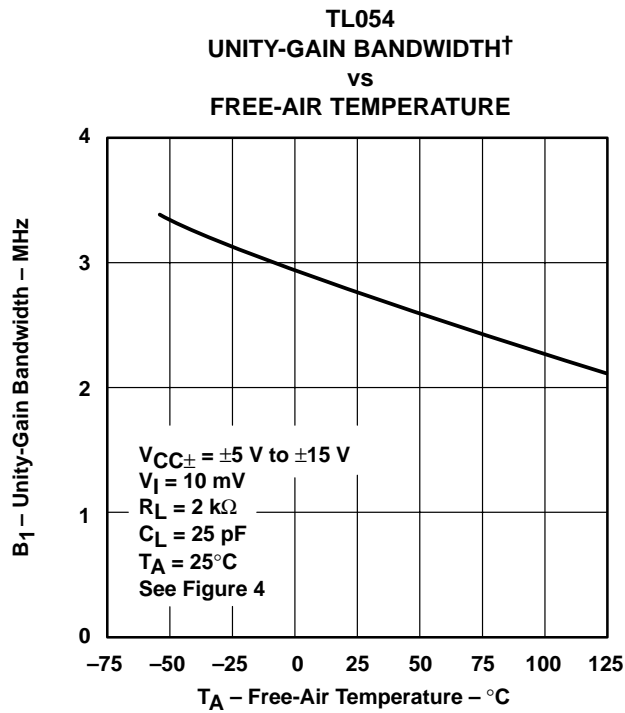

Figure 69

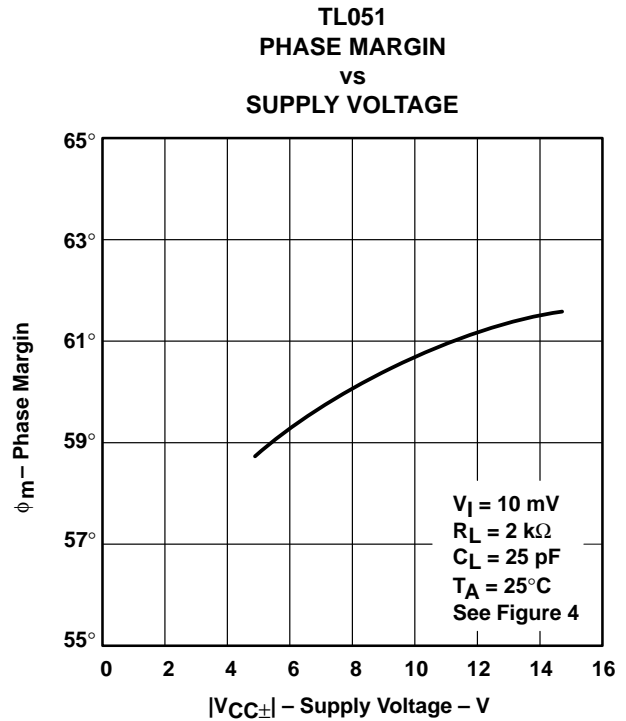

Figure 70

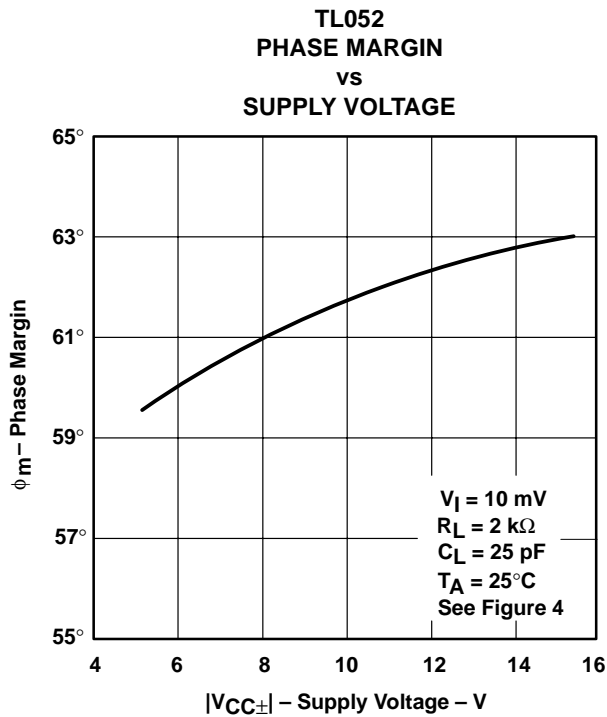

Figure 71

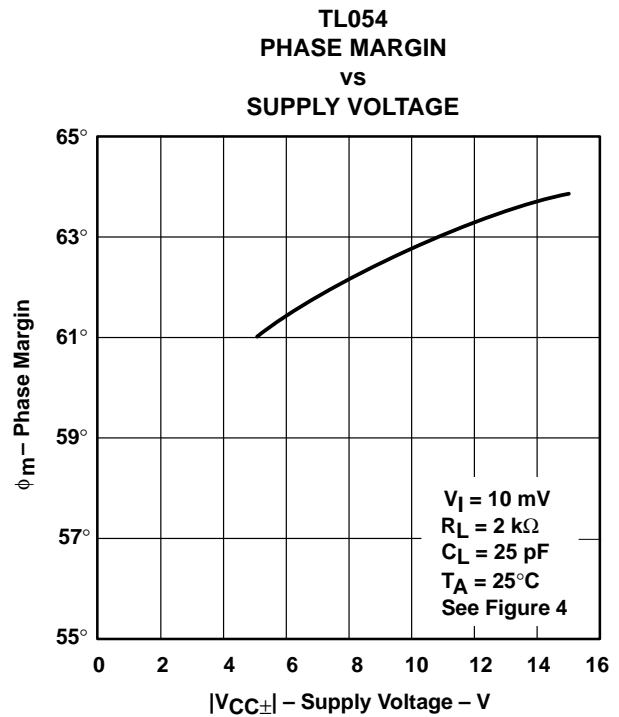

Figure 72

† Data at high and low temperatures are applicable only within the rated operating free-air temperature ranges of the various devices.

TL05x, TL05xA
ENHANCED-JFET LOW-OFFSET
OPERATIONAL AMPLIFIERS

SLOS178A – FEBRUARY 1997 - REVISED FEBRUARY 2003

TYPICAL CHARACTERISTICS

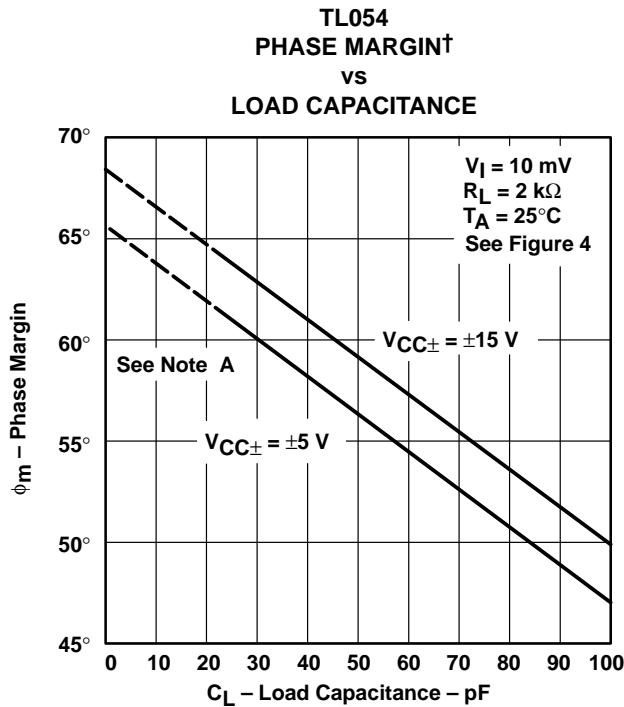
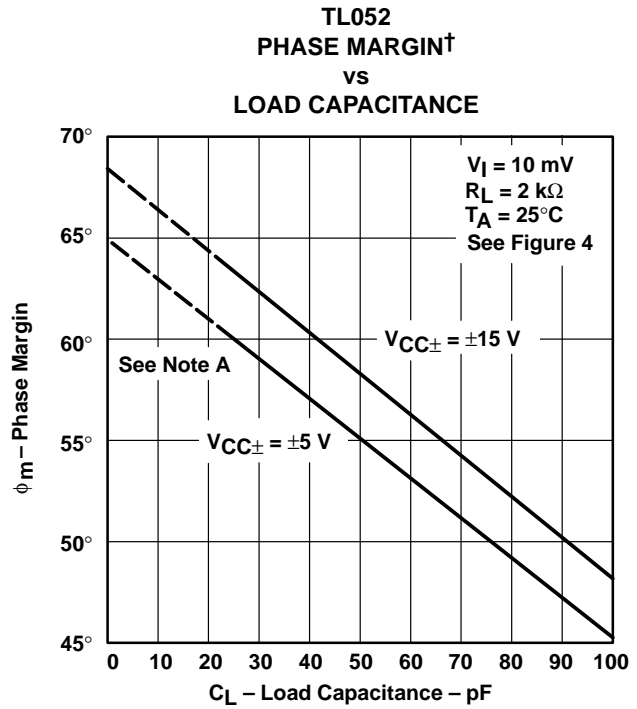
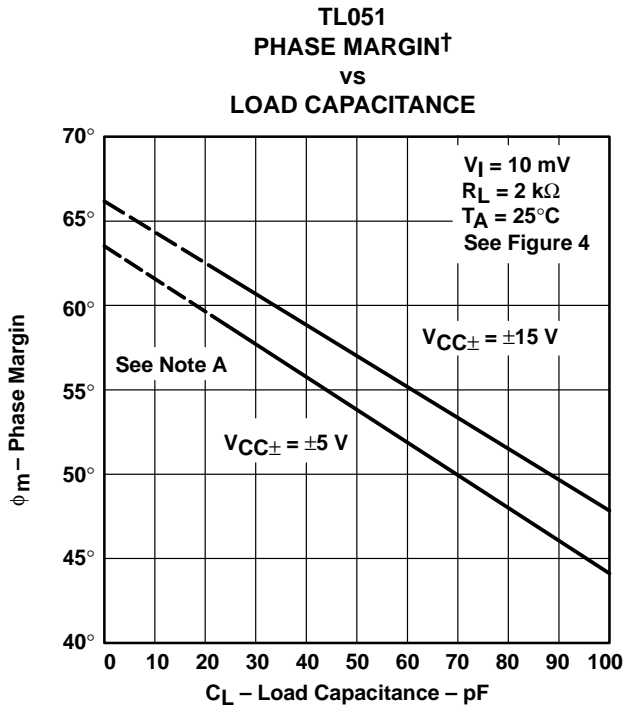

† Values of phase margin below a load capacitance of 25 pF were estimated.

TYPICAL CHARACTERISTICS

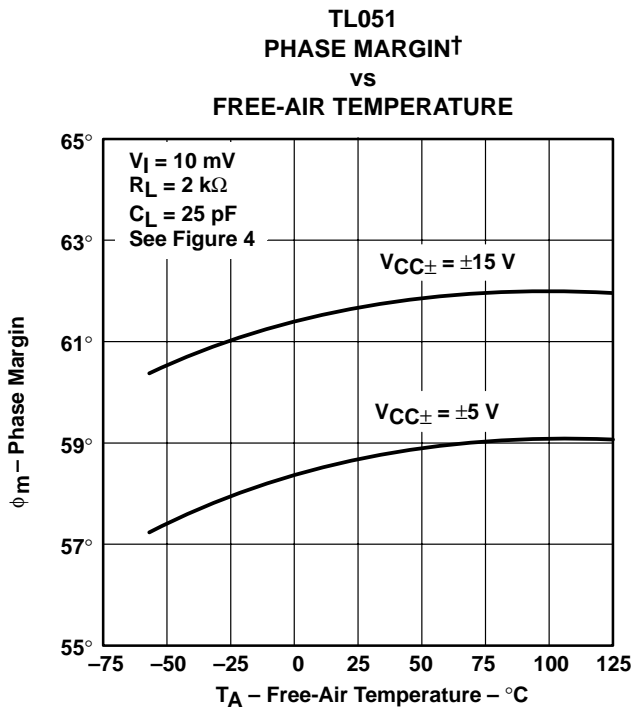

Figure 76

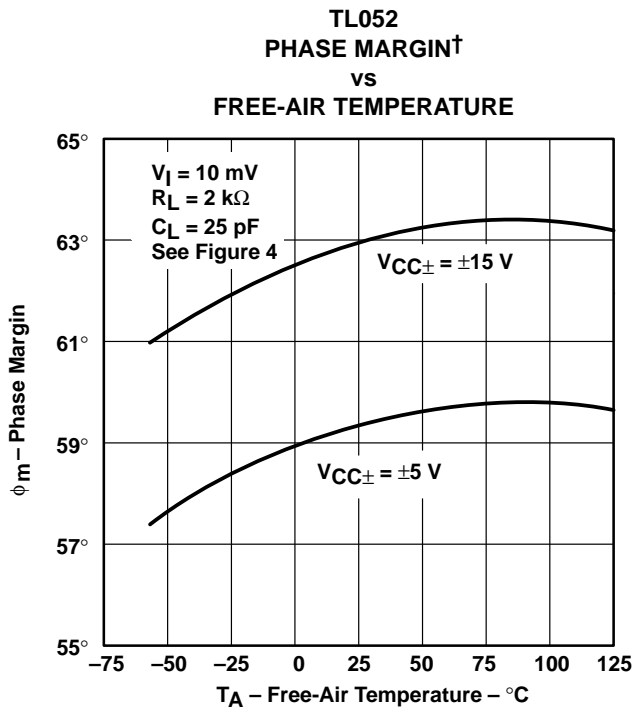

Figure 77

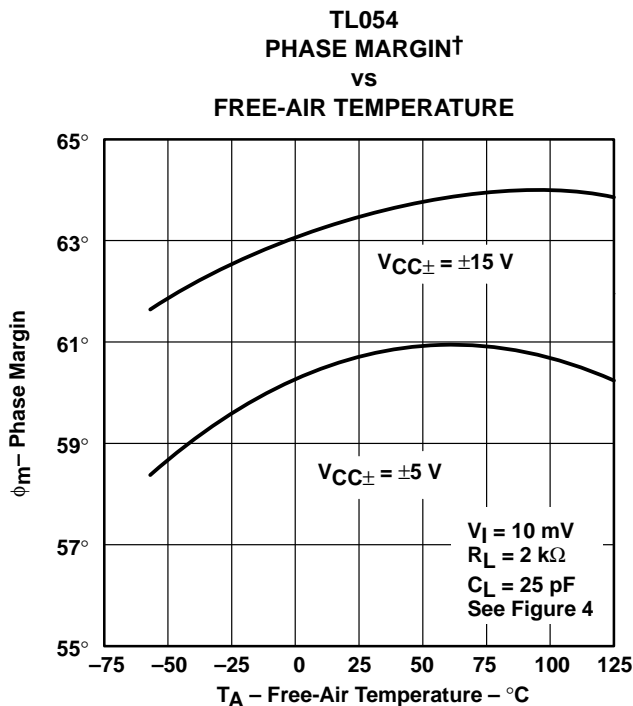

Figure 78

† Data at high and low temperatures are applicable only within the rated operating free-air temperature ranges of the various devices.

TL05x, TL05xA
ENHANCED-JFET LOW-OFFSET
OPERATIONAL AMPLIFIERS

SLOS178A – FEBRUARY 1997 - REVISED FEBRUARY 2003

TYPICAL CHARACTERISTICS

**VOLTAGE-FOLLOWER
SMALL-SIGNAL
PULSE RESPONSE**

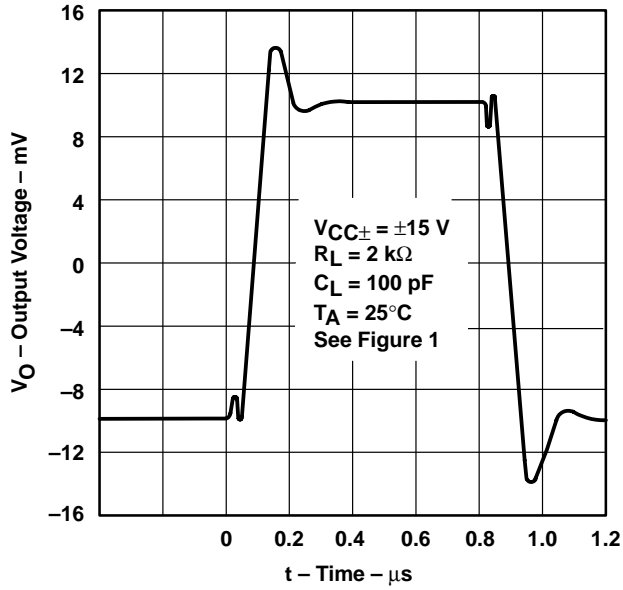

Figure 79

**VOLTAGE-FOLLOWER
LARGE-SIGNAL
PULSE RESPONSE**

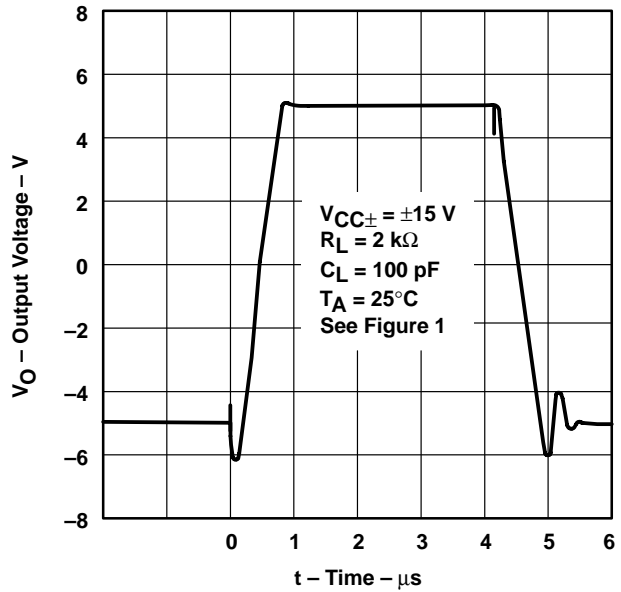

Figure 80

APPLICATION INFORMATION

output characteristics

All operating characteristics (except bandwidth and phase margin) are specified with 100-pF load capacitance. The TL05x and TL05xA drive higher capacitive loads; however, as the load capacitance increases, the resulting response pole occurs at lower frequencies, causing ringing, peaking, or even oscillation. The value of the load capacitance at which oscillation occurs varies with production lots. If an application appears to be sensitive to oscillation due to load capacitance, adding a small resistance in series with the load should alleviate the problem. Capacitive loads of 1000 pF, and larger, may be driven if enough resistance is added in series with the output (see Figure 81 and Figure 82).

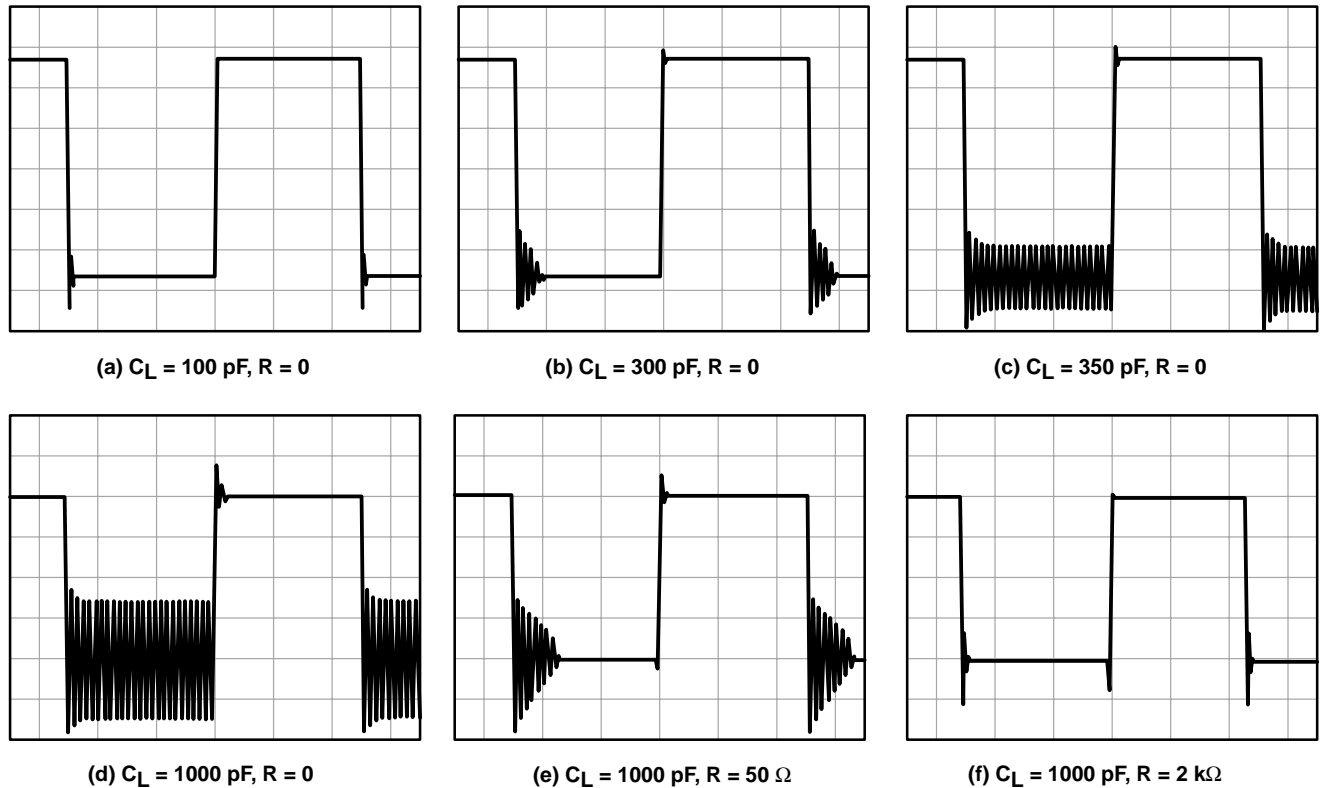
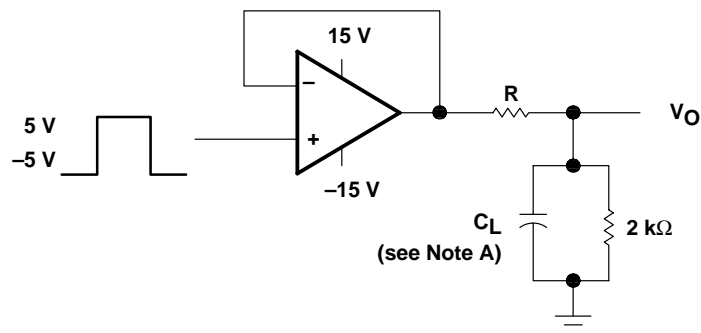

Figure 81. Effect of Capacitive Loads



NOTE A: C_L includes fixture capacitance.

Figure 82. Test Circuit for Output Characteristics

TL05x, TL05xA ENHANCED-JFET LOW-OFFSET OPERATIONAL AMPLIFIERS

SLOS178A – FEBRUARY 1997 - REVISED FEBRUARY 2003

APPLICATION INFORMATION

input characteristics

The TL05x and TL05xA are specified with a minimum and a maximum input voltage that, if exceeded at either input, could cause the device to malfunction.

Because of the extremely high input impedance and resulting low-bias current requirements, the TL05x and TL05xA are well suited for low-level signal processing; however, leakage currents on printed-circuit boards and sockets easily can exceed bias current requirements and cause degradation in system performance. It is good practice to include guard rings around inputs (see Figure 83). These guards should be driven from a low-impedance source at the same voltage level as the common-mode input.

Unused amplifiers should be connected as grounded unity-gain followers to avoid possible oscillation.

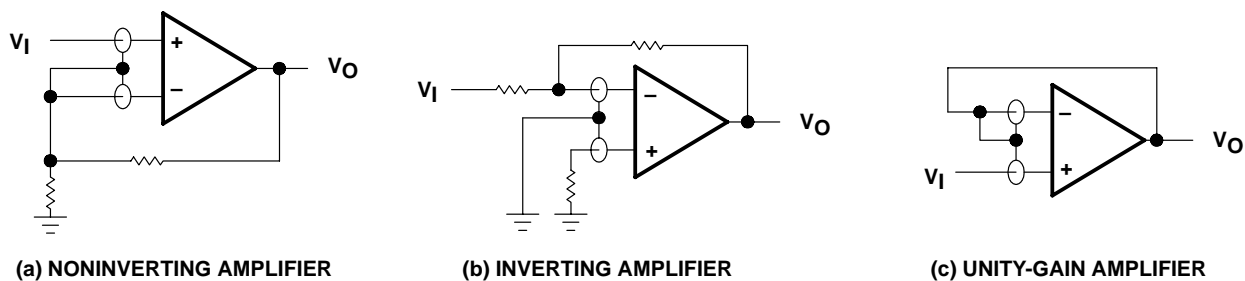

Figure 83. Use of Guard Rings

noise performance

The noise specifications in operational amplifier circuits are greatly dependent on the current in the first-stage differential amplifier. The low input-bias current requirements of the TL05x and TL05xA result in a very low current noise. This feature makes the devices especially favorable over bipolar devices when using values of circuit impedance greater than 50 k Ω .

APPLICATION INFORMATION

phase meter

The phase meter in Figure 84 produces an output voltage of 10 mV per degree of phase delay between the two input signals V_A and V_B . The reference signal V_A must be the same frequency as V_B . The TLC3702 comparators (U1) convert these two input sine waves into ± 5 -V square waves. Then, R1 and R4 provide level shifting prior to the SN74HC109 dual J-K flip flops.

Flip-flop U2B is connected as a toggle flip-flop and generates a square wave at one-half the frequency of V_B . Flip-flop U2A also produces a square wave at one-half the input frequency. The pulse duration of U2A varies from zero to one-half the period, where zero corresponds to zero phase delay between V_A and V_B and one-half the period corresponds to V_B lagging V_A by 360 degrees.

The output pulse from U2A causes the TLC4066 (U3) switch to charge the TL05x (U4) integrator capacitors C1 and C2. As the phase delay approaches 360 degrees, the output of U4A approximates a square wave, and U2A has an output of almost 2.5 V. U4B acts as a noninverting amplifier with a gain of 1.44 in order to scale the 0- to 2.5-V integrator output to a 0- to 3.6-V output range.

R8 and R10 provide output gain and zero-level calibration. This circuit operates over a 100-Hz to 10-kHz frequency range.

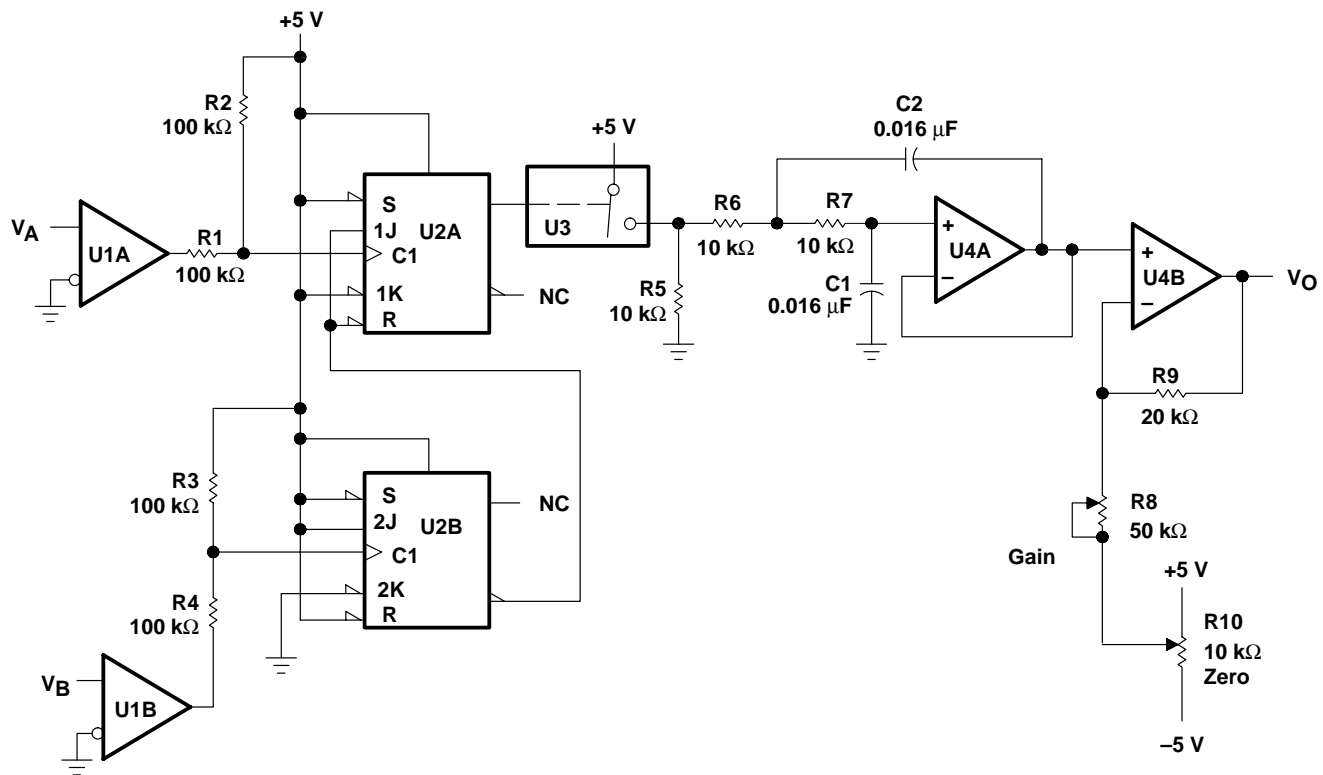

NOTE A: U1 = TLC3702; $V_{CC\pm} = \pm 5$ V
 U2 = SN74HC109
 U3 = TLC4066
 U4, U5 = TL05x; $V_{CC\pm} = \pm 5$ V

Figure 84. Phase Meter

TL05x, TL05xA ENHANCED-JFET LOW-OFFSET OPERATIONAL AMPLIFIERS

SLOS178A – FEBRUARY 1997 - REVISED FEBRUARY 2003

APPLICATION INFORMATION

precision constant-current source over temperature

A precision current source (see Figure 85) benefits from the high input impedance and stability of Texas Instruments enhanced-JFET process. A low-current shunt regulator maintains 2.5 V between the inverting input and the output of the TL05x. The negative feedback then forces 2.5 V across the current-setting resistor R; therefore, the current to the load simply is 2.5 V divided by R.

Possible choices for the shunt regulator include the LM385, LM339, and LM335. If the regulator's cathode connects to the operational amplifier output, this circuit sources load current. Similarly, if the cathode connects to the inverting input, the circuit sinks current from the load. To minimize output current change with temperature, R should be a metal film resistor with a low temperature coefficient. Also, this circuit must be operated with split-voltage supplies.

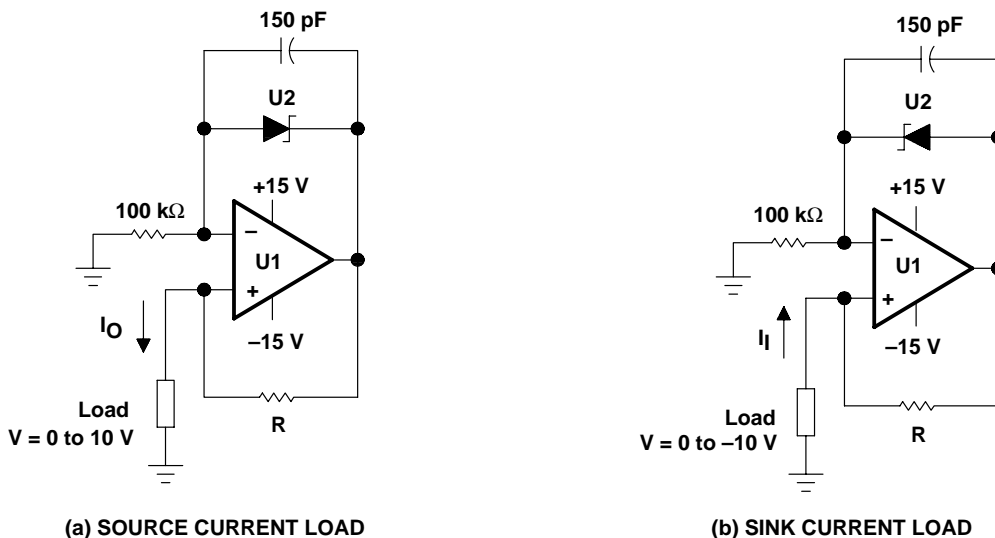

NOTE A: U1 = 1/2 TL05x
 U2 = LM385, LM339, or LM335 voltage reference
 $I = \frac{2.5 \text{ V}}{R}$, R = Low-temperature-coefficient metal-film resistor

Figure 85. Precision Constant-Current Source

APPLICATION INFORMATION

instrumentation amplifier with adjustable gain/null

The instrumentation amplifier in Figure 86 benefits greatly from the high input impedance and stable input offset voltage of the TL05xA. Amplifiers U1A, U1B, and U2A form the actual instrumentation amplifier, while U2B provides offset null. Potentiometer R1 provides gain adjustment. With R1 = 2 kΩ, the circuit gain equals 100, while with R1 = 200 kΩ, the circuit gain equals two. The following equation shows the instrumentation amplifier gain as a function of R1:

$$A_v = 1 + \left(\frac{R2 + R3}{R1} \right)$$

Readjusting the offset null is necessary when the circuit gain is changed. If U2B is needed for another application, R7 can be terminated at ground. The low input offset voltage of the TL05xA minimizes the dc error of the circuit. For best matching, all resistors should be one-percent tolerance. The matching between R4, R5, R6, and R7 controls the CMRR of this application.

The following equation shows the output voltages when the input voltage equals zero. This dc error can be nulled by adjusting the offset null potentiometer; however, any change in offset voltage over time or temperature also creates an error. To calculate the error from changes in offset, consider the three offset components in the equation as delta offsets, rather than initial offsets. The improved stability of Texas Instruments enhanced JFETs minimizes the error resulting from change in input offset voltage with time. Assuming V_I equals zero, V_O can be shown as a function of the offset voltage:

$$V_O = V_{IO2} \left[\left(1 + \frac{R3}{R1} \right) \left(\frac{R7}{R5 + R7} \right) \left(1 + \frac{R6}{R4} \right) + \frac{R2}{R1} \left(\frac{R6}{R4} \right) \right] - V_{IO1} \left[\frac{R3}{R1} \left(\frac{R7}{R5 + R7} \right) \left(1 + \frac{R6}{R4} \right) + \frac{R6}{R4} \left(1 + \frac{R2}{R1} \right) \right] + V_{IO3} \left(1 + \frac{R6}{R4} \right)$$

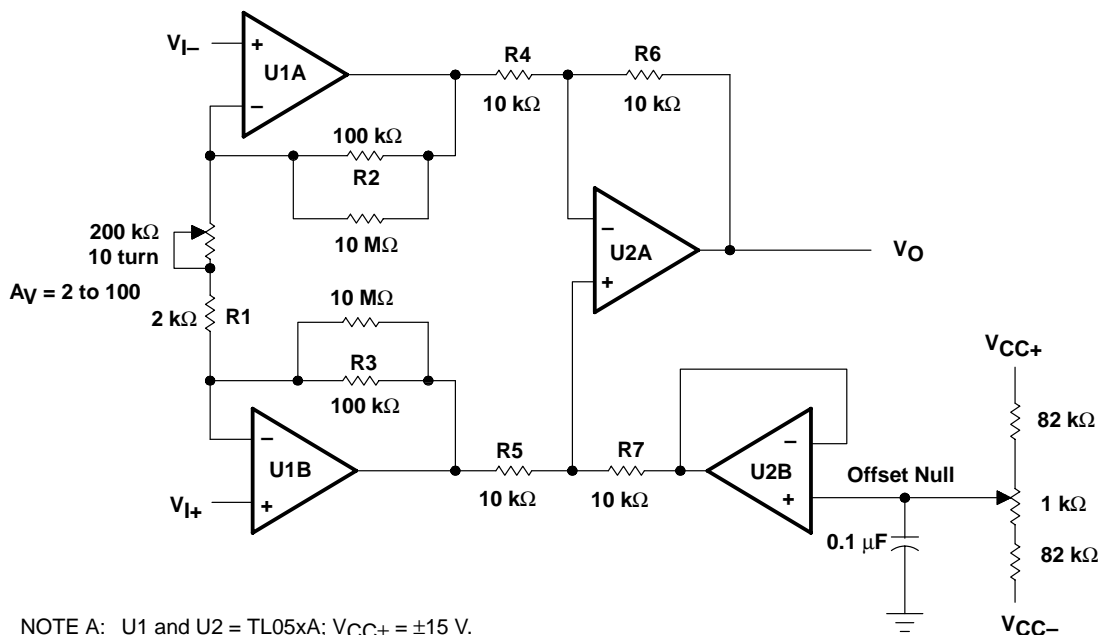

Figure 86. Instrumentation Amplifier

APPLICATION INFORMATION

high input impedance log amplifier

The low input offset voltage and high input impedance of the TL05xA creates a precision log amplifier (see Figure 87). IC1 is a 2.5-V, low-current precision, shunt regulator. Transistors Q1 and Q2 must be a closely matched npn pair. For best performance over temperature, R4 should be a metal-film resistor with a low temperature coefficient.

In this circuit, U1A serves as a high-impedance unity-gain buffer. Amplifier U1B converts the input voltage to a current through R1 and Q1. Amplifier U1C, IC1, and R4 form a 1-μA temperature-stable current source that sets the base-emitter voltage of Q2. U1D amplifies the difference between the base-emitter voltage of Q1 and Q2 (see Figure 88). The output voltage is given by the following equation:

$$V_O = -\left[1 + \frac{R_6}{R_5}\right] \frac{kT}{q} \left[\ln \frac{V_I}{(R_1 \times 1 \times 10^{-6})} \right]$$

where $k = 1.38 \times 10^{-23}$, $q = 1.602 \times 10^{-19}$, and T is Kelvin temperature

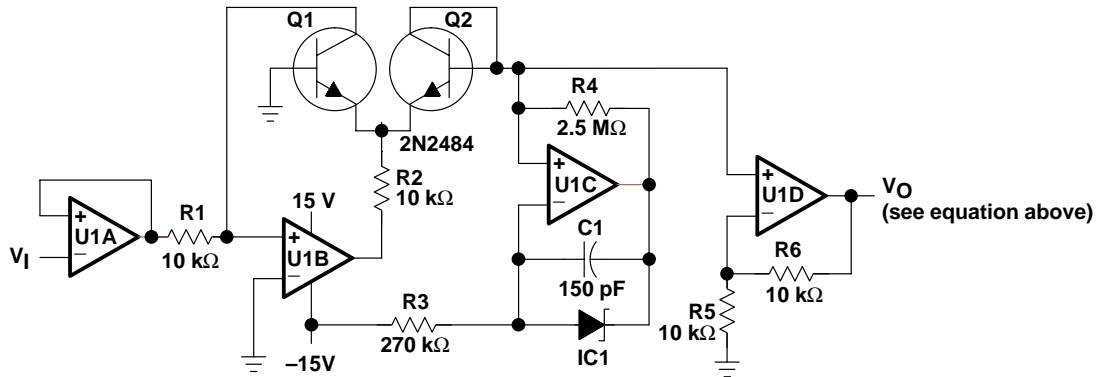

NOTE A: U1A through U1D = TL05xA. IC1 = LM385, LT1004, or LT1009 voltage reference

Figure 87. Log Amplifier

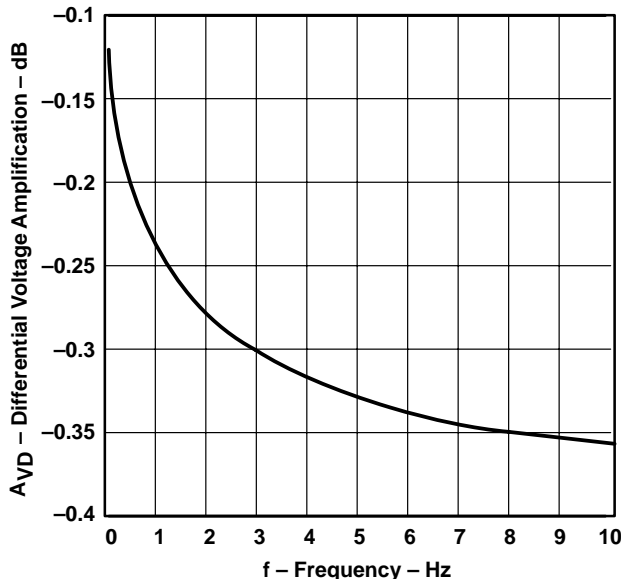

Figure 88. Output Voltage vs Input Voltage for Log Amplifier

APPLICATION INFORMATION

analog thermometer

By combining a current source that does not vary over temperature with an instrumentation amplifier, a precise analog thermometer can be built (see Figure 89). Amplifier U1A and IC1 establish a constant current through the temperature-sensing diode D1. For this section of the circuit to operate correctly, the TL05x must use split supplies, and R3 must be a metal-film resistor with a low temperature coefficient.

The temperature-sensitive voltage from the diode is compared to a temperature-stable voltage reference set by IC2. R4 should be adjusted to provide the correct output voltage when the diode is at a known temperature. Although this potentiometer resistance varies with temperature, the divider ratio of the potentiometer remains constant.

Amplifiers U1B, U2A, and U2B form the instrumentation amplifier that converts the difference between the diode and reference voltage to a voltage proportional to the temperature. With switch S1 closed, the amplifier gain equals 5 and the output voltage is proportional to temperature in degrees Celsius. With S1 open, the amplifier gain is 9 and the output is proportional to temperature in degrees Fahrenheit. Every time S1 is changed, R4 must be recalibrated. By setting S1 correctly, the output voltage equals 10 mV per degree (C or F).

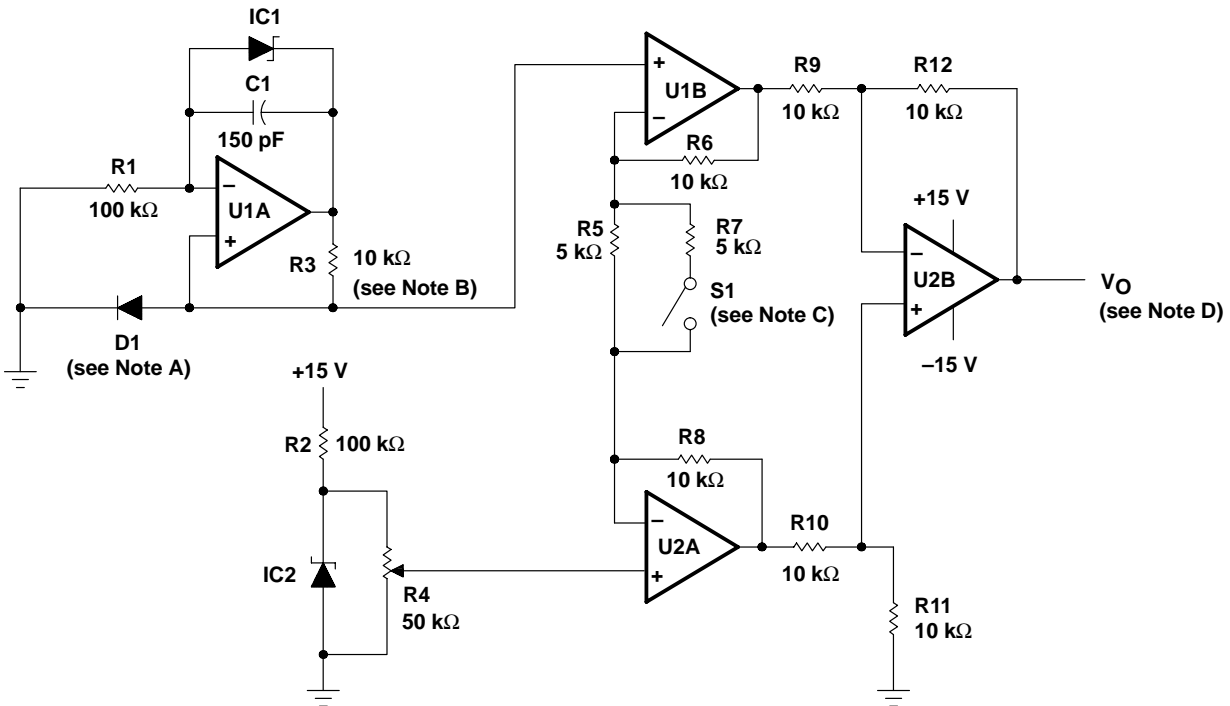

- NOTES: A. Temperature-sensing diode $\approx (-2 \text{ mV}/^\circ\text{C})$
 B. Metal-film resistor (low temperature coefficient)
 C. Switch open for $^\circ\text{F}$ and closed for $^\circ\text{C}$
 D. $V_O \propto \text{temperature}$; $10 \text{ mV}/^\circ\text{C}$ or $10 \text{ mV}/^\circ\text{F}$
 E. U1, U2 = TL05x. IC1, IC2 = LM385, LT1004, or LT1009 voltage reference

Figure 89. Analog Thermometer

APPLICATION INFORMATION

voltage-ratio-to-dB converter

The application in Figure 90 measures the amplitude ratio of two signals, then converts the ratio to decibels (see Figure 91). The output voltage provides a resolution of 100 mV/dB. The two inputs can be either dc or sinusoidal ac signals. When using ac signals, both signals should be the same frequency or output glitches will occur. For measuring two input signals of different frequencies, extra filtering should be added after the rectifiers.

The circuit contains three low-offset TL05xA devices. Two of these devices provide the rectification and logarithmic conversion of the inputs. The third TL05xA forms an instrumentation amplifier. The stage performing the logarithmic conversion also requires two well-matched npn transistors.

The input signal first passes through a high-impedance unity-gain buffer U1A (U2A). Then U1B (U2B) rectifies the input signal at a gain of 0.5, and U1C (U2C) provides a noninverting gain of 2, so that the system gain is still one. U1D (U2D), R6 (R13), and Q1 (Q2) perform the logarithmic conversion of the rectified input signal. The instrumentation amplifier formed by U3A, U3B, U3D scales the difference of the two logarithmic voltages by a gain of 33.6. As a result, the output voltage equals 100 mV/dB. The 1-kΩ potentiometer on the input of U3C calibrates the zero-dB reference level. The following equations are used to derive the relationship between the input voltage ratio, expressed in decibels, and the output voltage.

$$X \text{ dB} = 20 \log \left[\frac{V_A}{V_B} \right] = 20 \left[\frac{\ln(V_A) - \ln(V_B)}{\ln(10)} \right]$$

$$X \text{ dB} = 8.686 \left[\ln(V_A) - \ln(V_B) \right]$$

$$V_{BE(Q1)} = \frac{kT}{q} \ln \left[\frac{V_A}{R \times I_S} \right] \quad V_{BE(Q2)} = \frac{kT}{q} \ln \left[\frac{V_B}{R \times I_S} \right]$$

$$\Delta V_{BE} = V_{BE(Q1)} - V_{BE(Q2)} = \frac{kT}{q} \left[\ln(V_A) - \ln(V_B) \right]$$

$$X \text{ dB} = \frac{8.686}{kT/q} \left[V_{BE(Q1)} - V_{BE(Q2)} \right] = 336 \left[V_{BE(Q1)} - V_{BE(Q2)} \right] \text{ at } 25^\circ\text{C}$$

where

$$k = 1.38 \times 10^{-23}, \quad q = 1.602 \times 10^{-19}, \quad \text{and } T \text{ is Kelvin temperature}$$

This gives a resolution of 1 V/dB. Therefore, the gain of the instrumentation amplifier is set at 33.6 to obtain 100 mV/dB.

APPLICATION INFORMATION

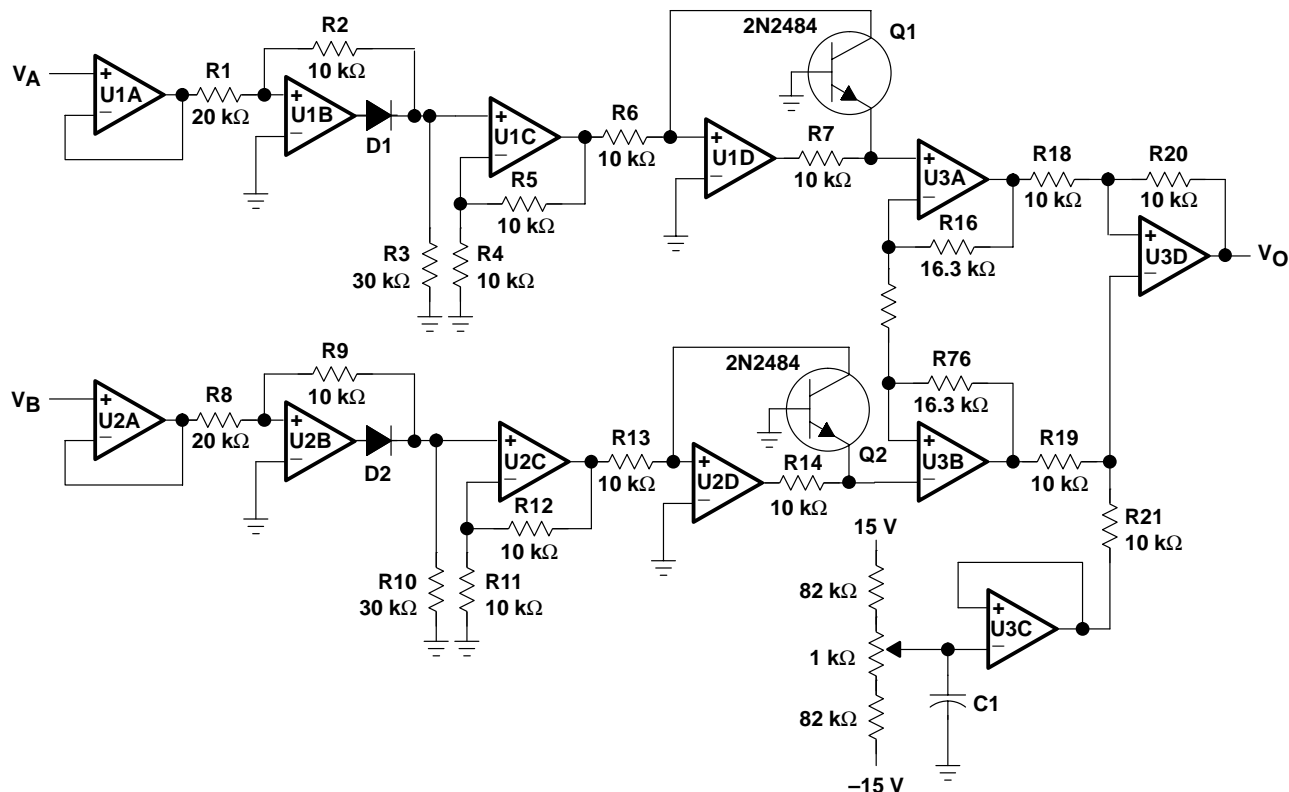

NOTE A: U1A through U3D = TL05xA, $V_{CC\pm} = \pm 15$ V. D1 and D2 = 1N914.

Figure 90. Voltage Ratio-to-dB Converter

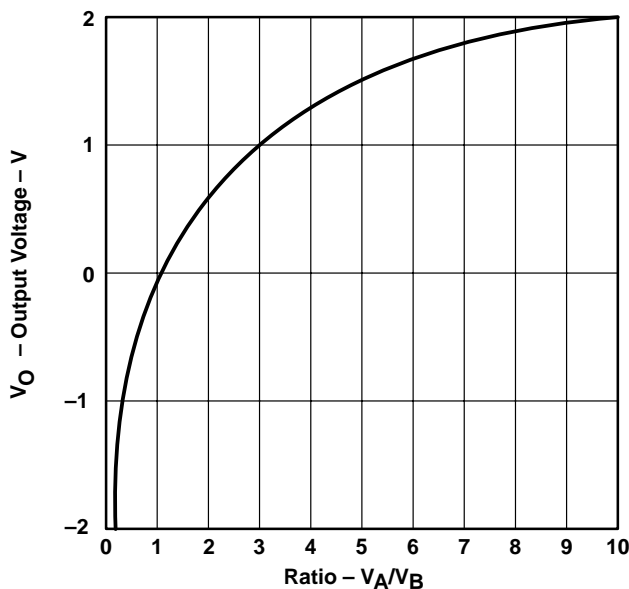

Figure 91. Output Voltage vs the Ratio of the Input Voltages for Voltage-to-dB Converter

TL05x, TL05xA ENHANCED-JFET LOW-OFFSET OPERATIONAL AMPLIFIERS

SLOS178A – FEBRUARY 1997 - REVISED FEBRUARY 2003

APPLICATION INFORMATION

macromodel information

Macromodel information provided was derived using Microsim *Parts*™, the model-generation software used with Microsim *PSpice*™. The Boyle macromodel (see Note 6 and subcircuit Figure 92) are generated using the TL05x typical electrical and operating characteristics at $T_A = 25^\circ\text{C}$. Using this information, output simulations of the following key parameters can be generated to a tolerance of 20% (in most cases):

- Maximum positive output voltage swing
- Maximum negative output voltage swing
- Slew rate
- Quiescent power dissipation
- Input bias current
- Open-loop voltage amplification
- Unity-gain frequency
- Common-mode rejection ratio
- Phase margin
- DC output resistance
- AC output resistance
- Short-circuit output current limit

NOTE 6: G. R. Boyle, B. M. Cohn, D. O. Pederson, and J. E. Solomon, "Macromodeling of Integrated Circuit Operational Amplifiers", *IEEE Journal of Solid-State Circuits*, SC-9, 353 (1974).

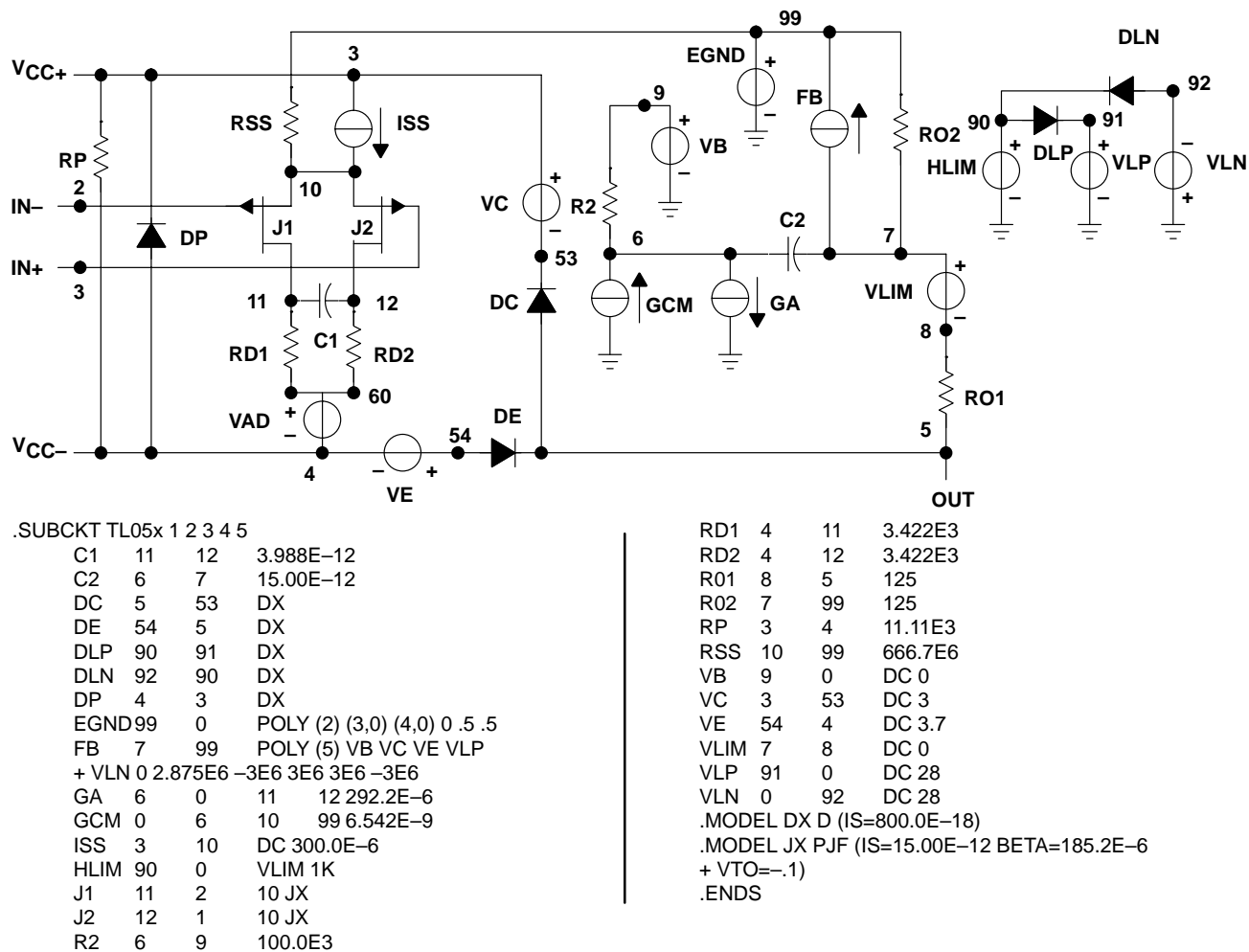

Figure 92. Boyle Macromodel and Subcircuit

PSpice and *Parts* are trademarks of MicroSim Corporation.

Macromodels, simulation models, or other models provided by TI, directly or indirectly, are not warranted by TI as fully representing all of the specification and operating characteristics of the semiconductor product to which the model relates.



POST OFFICE BOX 655303 • DALLAS, TEXAS 75265

IMPORTANT NOTICE

Texas Instruments Incorporated and its subsidiaries (TI) reserve the right to make corrections, modifications, enhancements, improvements, and other changes to its products and services at any time and to discontinue any product or service without notice. Customers should obtain the latest relevant information before placing orders and should verify that such information is current and complete. All products are sold subject to TI's terms and conditions of sale supplied at the time of order acknowledgment.

TI warrants performance of its hardware products to the specifications applicable at the time of sale in accordance with TI's standard warranty. Testing and other quality control techniques are used to the extent TI deems necessary to support this warranty. Except where mandated by government requirements, testing of all parameters of each product is not necessarily performed.

TI assumes no liability for applications assistance or customer product design. Customers are responsible for their products and applications using TI components. To minimize the risks associated with customer products and applications, customers should provide adequate design and operating safeguards.

TI does not warrant or represent that any license, either express or implied, is granted under any TI patent right, copyright, mask work right, or other TI intellectual property right relating to any combination, machine, or process in which TI products or services are used. Information published by TI regarding third-party products or services does not constitute a license from TI to use such products or services or a warranty or endorsement thereof. Use of such information may require a license from a third party under the patents or other intellectual property of the third party, or a license from TI under the patents or other intellectual property of TI.

Reproduction of information in TI data books or data sheets is permissible only if reproduction is without alteration and is accompanied by all associated warranties, conditions, limitations, and notices. Reproduction of this information with alteration is an unfair and deceptive business practice. TI is not responsible or liable for such altered documentation.

Resale of TI products or services with statements different from or beyond the parameters stated by TI for that product or service voids all express and any implied warranties for the associated TI product or service and is an unfair and deceptive business practice. TI is not responsible or liable for any such statements.

TI products are not authorized for use in safety-critical applications (such as life support) where a failure of the TI product would reasonably be expected to cause severe personal injury or death, unless officers of the parties have executed an agreement specifically governing such use. Buyers represent that they have all necessary expertise in the safety and regulatory ramifications of their applications, and acknowledge and agree that they are solely responsible for all legal, regulatory and safety-related requirements concerning their products and any use of TI products in such safety-critical applications, notwithstanding any applications-related information or support that may be provided by TI. Further, Buyers must fully indemnify TI and its representatives against any damages arising out of the use of TI products in such safety-critical applications.

TI products are neither designed nor intended for use in military/aerospace applications or environments unless the TI products are specifically designated by TI as military-grade or "enhanced plastic." Only products designated by TI as military-grade meet military specifications. Buyers acknowledge and agree that any such use of TI products which TI has not designated as military-grade is solely at the Buyer's risk, and that they are solely responsible for compliance with all legal and regulatory requirements in connection with such use.

TI products are neither designed nor intended for use in automotive applications or environments unless the specific TI products are designated by TI as compliant with ISO/TS 16949 requirements. Buyers acknowledge and agree that, if they use any non-designated products in automotive applications, TI will not be responsible for any failure to meet such requirements.

Following are URLs where you can obtain information on other Texas Instruments products and application solutions:

Products		Applications	
Amplifiers	amplifier.ti.com	Audio	www.ti.com/audio
Data Converters	dataconverter.ti.com	Automotive	www.ti.com/automotive
DSP	dsp.ti.com	Broadband	www.ti.com/broadband
Interface	interface.ti.com	Digital Control	www.ti.com/digitalcontrol
Logic	logic.ti.com	Military	www.ti.com/military
Power Mgmt	power.ti.com	Optical Networking	www.ti.com/opticalnetwork
Microcontrollers	microcontroller.ti.com	Security	www.ti.com/security
Low Power Wireless	www.ti.com/lpw	Telephony	www.ti.com/telephony
		Video & Imaging	www.ti.com/video
		Wireless	www.ti.com/wireless

Mailing Address: Texas Instruments, Post Office Box 655303, Dallas, Texas 75265
Copyright © 2007, Texas Instruments Incorporated

PACKAGING INFORMATION

Orderable Device	Status ⁽¹⁾	Package Type	Package Drawing	Pins	Package Qty	Eco Plan ⁽²⁾	Lead/Ball Finish	MSL Peak Temp ⁽³⁾
TL051ACD	ACTIVE	SOIC	D	8	75	Green (RoHS & no Sb/Br)	CU NIPDAU	Level-1-260C-UNLIM
TL051ACDE4	ACTIVE	SOIC	D	8	75	Green (RoHS & no Sb/Br)	CU NIPDAU	Level-1-260C-UNLIM
TL051ACDG4	ACTIVE	SOIC	D	8	75	Green (RoHS & no Sb/Br)	CU NIPDAU	Level-1-260C-UNLIM
TL051ACP	ACTIVE	PDIP	P	8	50	Pb-Free (RoHS)	CU NIPDAU	N / A for Pkg Type
TL051ACPE4	ACTIVE	PDIP	P	8	50	Pb-Free (RoHS)	CU NIPDAU	N / A for Pkg Type
TL051AID	OBSOLETE	SOIC	D	8		TBD	Call TI	Call TI
TL051AIP	OBSOLETE	PDIP	P	8		TBD	Call TI	Call TI
TL051CD	ACTIVE	SOIC	D	8	75	Green (RoHS & no Sb/Br)	CU NIPDAU	Level-1-260C-UNLIM
TL051CDE4	ACTIVE	SOIC	D	8	75	Green (RoHS & no Sb/Br)	CU NIPDAU	Level-1-260C-UNLIM
TL051CDG4	ACTIVE	SOIC	D	8	75	Green (RoHS & no Sb/Br)	CU NIPDAU	Level-1-260C-UNLIM
TL051CDR	ACTIVE	SOIC	D	8	2500	Green (RoHS & no Sb/Br)	CU NIPDAU	Level-1-260C-UNLIM
TL051CDRE4	ACTIVE	SOIC	D	8	2500	Green (RoHS & no Sb/Br)	CU NIPDAU	Level-1-260C-UNLIM
TL051CDRG4	ACTIVE	SOIC	D	8	2500	Green (RoHS & no Sb/Br)	CU NIPDAU	Level-1-260C-UNLIM
TL051CP	ACTIVE	PDIP	P	8	50	Pb-Free (RoHS)	CU NIPDAU	N / A for Pkg Type
TL051CPE4	ACTIVE	PDIP	P	8	50	Pb-Free (RoHS)	CU NIPDAU	N / A for Pkg Type
TL051ID	OBSOLETE	SOIC	D	8		TBD	Call TI	Call TI
TL051IDR	OBSOLETE	SOIC	D	8		TBD	Call TI	Call TI
TL051IP	OBSOLETE	PDIP	P	8		TBD	Call TI	Call TI
TL052ACD	ACTIVE	SOIC	D	8	75	Green (RoHS & no Sb/Br)	CU NIPDAU	Level-1-260C-UNLIM
TL052ACDE4	ACTIVE	SOIC	D	8	75	Green (RoHS & no Sb/Br)	CU NIPDAU	Level-1-260C-UNLIM
TL052ACDG4	ACTIVE	SOIC	D	8	75	Green (RoHS & no Sb/Br)	CU NIPDAU	Level-1-260C-UNLIM
TL052ACDR	ACTIVE	SOIC	D	8	2500	Green (RoHS & no Sb/Br)	CU NIPDAU	Level-1-260C-UNLIM
TL052ACDRE4	ACTIVE	SOIC	D	8	2500	Green (RoHS & no Sb/Br)	CU NIPDAU	Level-1-260C-UNLIM
TL052ACDRG4	ACTIVE	SOIC	D	8	2500	Green (RoHS & no Sb/Br)	CU NIPDAU	Level-1-260C-UNLIM
TL052ACP	ACTIVE	PDIP	P	8	50	Pb-Free (RoHS)	CU NIPDAU	N / A for Pkg Type
TL052ACPE4	ACTIVE	PDIP	P	8	50	Pb-Free (RoHS)	CU NIPDAU	N / A for Pkg Type
TL052AID	ACTIVE	SOIC	D	8	75	Green (RoHS & no Sb/Br)	CU NIPDAU	Level-1-260C-UNLIM

Orderable Device	Status ⁽¹⁾	Package Type	Package Drawing	Pins	Package Qty	Eco Plan ⁽²⁾	Lead/Ball Finish	MSL Peak Temp ⁽³⁾
TL052AIDE4	ACTIVE	SOIC	D	8	75	Green (RoHS & no Sb/Br)	CU NIPDAU	Level-1-260C-UNLIM
TL052AIDG4	ACTIVE	SOIC	D	8	75	Green (RoHS & no Sb/Br)	CU NIPDAU	Level-1-260C-UNLIM
TL052AIDR	ACTIVE	SOIC	D	8	2500	Green (RoHS & no Sb/Br)	CU NIPDAU	Level-1-260C-UNLIM
TL052AIDRE4	ACTIVE	SOIC	D	8	2500	Green (RoHS & no Sb/Br)	CU NIPDAU	Level-1-260C-UNLIM
TL052AIDRG4	ACTIVE	SOIC	D	8	2500	Green (RoHS & no Sb/Br)	CU NIPDAU	Level-1-260C-UNLIM
TL052AIP	ACTIVE	PDIP	P	8	50	Pb-Free (RoHS)	CU NIPDAU	N / A for Pkg Type
TL052AIPE4	ACTIVE	PDIP	P	8	50	Pb-Free (RoHS)	CU NIPDAU	N / A for Pkg Type
TL052AMFKB	OBSOLETE	LCCC	FK	20		TBD	Call TI	Call TI
TL052AMJGB	OBSOLETE	CDIP	JG	8		TBD	Call TI	Call TI
TL052CD	ACTIVE	SOIC	D	8	75	Green (RoHS & no Sb/Br)	CU NIPDAU	Level-1-260C-UNLIM
TL052CDE4	ACTIVE	SOIC	D	8	75	Green (RoHS & no Sb/Br)	CU NIPDAU	Level-1-260C-UNLIM
TL052CDG4	ACTIVE	SOIC	D	8	75	Green (RoHS & no Sb/Br)	CU NIPDAU	Level-1-260C-UNLIM
TL052CDR	ACTIVE	SOIC	D	8	2500	Green (RoHS & no Sb/Br)	CU NIPDAU	Level-1-260C-UNLIM
TL052CDRE4	ACTIVE	SOIC	D	8	2500	Green (RoHS & no Sb/Br)	CU NIPDAU	Level-1-260C-UNLIM
TL052CDRG4	ACTIVE	SOIC	D	8	2500	Green (RoHS & no Sb/Br)	CU NIPDAU	Level-1-260C-UNLIM
TL052CP	ACTIVE	PDIP	P	8	50	Pb-Free (RoHS)	CU NIPDAU	N / A for Pkg Type
TL052CPE4	ACTIVE	PDIP	P	8	50	Pb-Free (RoHS)	CU NIPDAU	N / A for Pkg Type
TL052CPSR	ACTIVE	SO	PS	8	2000	Green (RoHS & no Sb/Br)	CU NIPDAU	Level-1-260C-UNLIM
TL052CPSRE4	ACTIVE	SO	PS	8	2000	Green (RoHS & no Sb/Br)	CU NIPDAU	Level-1-260C-UNLIM
TL052CPSRG4	ACTIVE	SO	PS	8	2000	Green (RoHS & no Sb/Br)	CU NIPDAU	Level-1-260C-UNLIM
TL052ID	ACTIVE	SOIC	D	8	75	Green (RoHS & no Sb/Br)	CU NIPDAU	Level-1-260C-UNLIM
TL052IDE4	ACTIVE	SOIC	D	8	75	Green (RoHS & no Sb/Br)	CU NIPDAU	Level-1-260C-UNLIM
TL052IDG4	ACTIVE	SOIC	D	8	75	Green (RoHS & no Sb/Br)	CU NIPDAU	Level-1-260C-UNLIM
TL052IDR	ACTIVE	SOIC	D	8	2500	Green (RoHS & no Sb/Br)	CU NIPDAU	Level-1-260C-UNLIM
TL052IDRE4	ACTIVE	SOIC	D	8	2500	Green (RoHS & no Sb/Br)	CU NIPDAU	Level-1-260C-UNLIM
TL052IDRG4	ACTIVE	SOIC	D	8	2500	Green (RoHS & no Sb/Br)	CU NIPDAU	Level-1-260C-UNLIM
TL052IP	ACTIVE	PDIP	P	8	50	Pb-Free	CU NIPDAU	N / A for Pkg Type

Orderable Device	Status ⁽¹⁾	Package Type	Package Drawing	Pins	Package Qty	Eco Plan ⁽²⁾	Lead/Ball Finish	MSL Peak Temp ⁽³⁾
						(RoHS)		
TL052IPE4	ACTIVE	PDIP	P	8	50	Pb-Free (RoHS)	CU NIPDAU	N / A for Pkg Type
TL052MFKB	OBSOLETE	LCCC	FK	20		TBD	Call TI	Call TI
TL052MJG	OBSOLETE	CDIP	JG	8		TBD	Call TI	Call TI
TL052MJGB	OBSOLETE	CDIP	JG	8		TBD	Call TI	Call TI
TL054ACD	ACTIVE	SOIC	D	14	50	Green (RoHS & no Sb/Br)	CU NIPDAU	Level-1-260C-UNLIM
TL054ACDE4	ACTIVE	SOIC	D	14	50	Green (RoHS & no Sb/Br)	CU NIPDAU	Level-1-260C-UNLIM
TL054ACDG4	ACTIVE	SOIC	D	14	50	Green (RoHS & no Sb/Br)	CU NIPDAU	Level-1-260C-UNLIM
TL054ACDR	ACTIVE	SOIC	D	14	2500	Green (RoHS & no Sb/Br)	CU NIPDAU	Level-1-260C-UNLIM
TL054ACDRE4	ACTIVE	SOIC	D	14	2500	Green (RoHS & no Sb/Br)	CU NIPDAU	Level-1-260C-UNLIM
TL054ACDRG4	ACTIVE	SOIC	D	14	2500	Green (RoHS & no Sb/Br)	CU NIPDAU	Level-1-260C-UNLIM
TL054ACN	ACTIVE	PDIP	N	14	25	Pb-Free (RoHS)	CU NIPDAU	N / A for Pkg Type
TL054ACNE4	ACTIVE	PDIP	N	14	25	Pb-Free (RoHS)	CU NIPDAU	N / A for Pkg Type
TL054AID	ACTIVE	SOIC	D	14	50	Green (RoHS & no Sb/Br)	CU NIPDAU	Level-1-260C-UNLIM
TL054AIDE4	ACTIVE	SOIC	D	14	50	Green (RoHS & no Sb/Br)	CU NIPDAU	Level-1-260C-UNLIM
TL054AIDG4	ACTIVE	SOIC	D	14	50	Green (RoHS & no Sb/Br)	CU NIPDAU	Level-1-260C-UNLIM
TL054AIDR	ACTIVE	SOIC	D	14	2500	Green (RoHS & no Sb/Br)	CU NIPDAU	Level-1-260C-UNLIM
TL054AIDRE4	ACTIVE	SOIC	D	14	2500	Green (RoHS & no Sb/Br)	CU NIPDAU	Level-1-260C-UNLIM
TL054AIDRG4	ACTIVE	SOIC	D	14	2500	Green (RoHS & no Sb/Br)	CU NIPDAU	Level-1-260C-UNLIM
TL054AIN	ACTIVE	PDIP	N	14	25	Pb-Free (RoHS)	CU NIPDAU	N / A for Pkg Type
TL054AINE4	ACTIVE	PDIP	N	14	25	Pb-Free (RoHS)	CU NIPDAU	N / A for Pkg Type
TL054AMFKB	OBSOLETE	LCCC	FK	20		TBD	Call TI	Call TI
TL054AMJB	OBSOLETE	CDIP	J	14		TBD	Call TI	Call TI
TL054CD	ACTIVE	SOIC	D	14	50	Green (RoHS & no Sb/Br)	CU NIPDAU	Level-1-260C-UNLIM
TL054CDBR	ACTIVE	SSOP	DB	14	2000	Green (RoHS & no Sb/Br)	CU NIPDAU	Level-1-260C-UNLIM
TL054CDBRE4	ACTIVE	SSOP	DB	14	2000	Green (RoHS & no Sb/Br)	CU NIPDAU	Level-1-260C-UNLIM
TL054CDBRG4	ACTIVE	SSOP	DB	14	2000	Green (RoHS & no Sb/Br)	CU NIPDAU	Level-1-260C-UNLIM
TL054CDE4	ACTIVE	SOIC	D	14	50	Green (RoHS & no Sb/Br)	CU NIPDAU	Level-1-260C-UNLIM

Orderable Device	Status ⁽¹⁾	Package Type	Package Drawing	Pins	Package Qty	Eco Plan ⁽²⁾	Lead/Ball Finish	MSL Peak Temp ⁽³⁾
TL054CDG4	ACTIVE	SOIC	D	14	50	Green (RoHS & no Sb/Br)	CU NIPDAU	Level-1-260C-UNLIM
TL054CDR	ACTIVE	SOIC	D	14	2500	Green (RoHS & no Sb/Br)	CU NIPDAU	Level-1-260C-UNLIM
TL054CDRE4	ACTIVE	SOIC	D	14	2500	Green (RoHS & no Sb/Br)	CU NIPDAU	Level-1-260C-UNLIM
TL054CDRG4	ACTIVE	SOIC	D	14	2500	Green (RoHS & no Sb/Br)	CU NIPDAU	Level-1-260C-UNLIM
TL054CN	ACTIVE	PDIP	N	14	25	Pb-Free (RoHS)	CU NIPDAU	N / A for Pkg Type
TL054CNE4	ACTIVE	PDIP	N	14	25	Pb-Free (RoHS)	CU NIPDAU	N / A for Pkg Type
TL054CNSR	ACTIVE	SO	NS	14	2000	Green (RoHS & no Sb/Br)	CU NIPDAU	Level-1-260C-UNLIM
TL054CNSRE4	ACTIVE	SO	NS	14	2000	Green (RoHS & no Sb/Br)	CU NIPDAU	Level-1-260C-UNLIM
TL054CNSRG4	ACTIVE	SO	NS	14	2000	Green (RoHS & no Sb/Br)	CU NIPDAU	Level-1-260C-UNLIM
TL054ID	ACTIVE	SOIC	D	14	50	Green (RoHS & no Sb/Br)	CU NIPDAU	Level-1-260C-UNLIM
TL054IDE4	ACTIVE	SOIC	D	14	50	Green (RoHS & no Sb/Br)	CU NIPDAU	Level-1-260C-UNLIM
TL054IDG4	ACTIVE	SOIC	D	14	50	Green (RoHS & no Sb/Br)	CU NIPDAU	Level-1-260C-UNLIM
TL054IDR	ACTIVE	SOIC	D	14	2500	Green (RoHS & no Sb/Br)	CU NIPDAU	Level-1-260C-UNLIM
TL054IDRE4	ACTIVE	SOIC	D	14	2500	Green (RoHS & no Sb/Br)	CU NIPDAU	Level-1-260C-UNLIM
TL054IDRG4	ACTIVE	SOIC	D	14	2500	Green (RoHS & no Sb/Br)	CU NIPDAU	Level-1-260C-UNLIM
TL054IN	ACTIVE	PDIP	N	14	25	Pb-Free (RoHS)	CU NIPDAU	N / A for Pkg Type
TL054INE4	ACTIVE	PDIP	N	14	25	Pb-Free (RoHS)	CU NIPDAU	N / A for Pkg Type
TL054MFKB	OBSOLETE	LCCC	FK	20		TBD	Call TI	Call TI
TL054MJ	OBSOLETE	CDIP	J	14		TBD	Call TI	Call TI
TL054MJB	OBSOLETE	CDIP	J	14		TBD	Call TI	Call TI

⁽¹⁾ The marketing status values are defined as follows:

ACTIVE: Product device recommended for new designs.

LIFEBUY: TI has announced that the device will be discontinued, and a lifetime-buy period is in effect.

NRND: Not recommended for new designs. Device is in production to support existing customers, but TI does not recommend using this part in a new design.

PREVIEW: Device has been announced but is not in production. Samples may or may not be available.

OBSOLETE: TI has discontinued the production of the device.

⁽²⁾ Eco Plan - The planned eco-friendly classification: Pb-Free (RoHS), Pb-Free (RoHS Exempt), or Green (RoHS & no Sb/Br) - please check <http://www.ti.com/productcontent> for the latest availability information and additional product content details.

TBD: The Pb-Free/Green conversion plan has not been defined.

Pb-Free (RoHS): TI's terms "Lead-Free" or "Pb-Free" mean semiconductor products that are compatible with the current RoHS requirements for all 6 substances, including the requirement that lead not exceed 0.1% by weight in homogeneous materials. Where designed to be soldered at high temperatures, TI Pb-Free products are suitable for use in specified lead-free processes.

Pb-Free (RoHS Exempt): This component has a RoHS exemption for either 1) lead-based flip-chip solder bumps used between the die and package, or 2) lead-based die adhesive used between the die and leadframe. The component is otherwise considered Pb-Free (RoHS

compatible) as defined above.

Green (RoHS & no Sb/Br): TI defines "Green" to mean Pb-Free (RoHS compatible), and free of Bromine (Br) and Antimony (Sb) based flame retardants (Br or Sb do not exceed 0.1% by weight in homogeneous material)

⁽³⁾ MSL, Peak Temp. -- The Moisture Sensitivity Level rating according to the JEDEC industry standard classifications, and peak solder temperature.

Important Information and Disclaimer:The information provided on this page represents TI's knowledge and belief as of the date that it is provided. TI bases its knowledge and belief on information provided by third parties, and makes no representation or warranty as to the accuracy of such information. Efforts are underway to better integrate information from third parties. TI has taken and continues to take reasonable steps to provide representative and accurate information but may not have conducted destructive testing or chemical analysis on incoming materials and chemicals. TI and TI suppliers consider certain information to be proprietary, and thus CAS numbers and other limited information may not be available for release.

In no event shall TI's liability arising out of such information exceed the total purchase price of the TI part(s) at issue in this document sold by TI to Customer on an annual basis.

TAPE AND REEL INFORMATION



QUADRANT ASSIGNMENTS FOR PIN 1 ORIENTATION IN TAPE



*All dimensions are nominal

Device	Package Type	Package Drawing	Pins	SPQ	Reel Diameter (mm)	Reel Width W1 (mm)	A0 (mm)	B0 (mm)	K0 (mm)	P1 (mm)	W (mm)	Pin1 Quadrant
TL051CDR	SOIC	D	8	2500	330.0	12.4	6.4	5.2	2.1	8.0	12.0	Q1
TL052ACDR	SOIC	D	8	2500	330.0	12.4	6.4	5.2	2.1	8.0	12.0	Q1
TL052AIDR	SOIC	D	8	2500	330.0	12.4	6.4	5.2	2.1	8.0	12.0	Q1
TL052CDR	SOIC	D	8	2500	330.0	12.4	6.4	5.2	2.1	8.0	12.0	Q1
TL052CPSR	SO	PS	8	2000	330.0	16.4	8.2	6.6	2.5	12.0	16.0	Q1
TL052IDR	SOIC	D	8	2500	330.0	12.4	6.4	5.2	2.1	8.0	12.0	Q1
TL054ACDR	SOIC	D	14	2500	330.0	16.4	6.5	9.0	2.1	8.0	16.0	Q1
TL054AIDR	SOIC	D	14	2500	330.0	16.4	6.5	9.0	2.1	8.0	16.0	Q1
TL054CDBR	SSOP	DB	14	2000	330.0	16.4	8.2	6.6	2.5	12.0	16.0	Q1
TL054CDR	SOIC	D	14	2500	330.0	16.4	6.5	9.0	2.1	8.0	16.0	Q1
TL054CNSR	SO	NS	14	2000	330.0	16.4	8.2	10.5	2.5	12.0	16.0	Q1
TL054IDR	SOIC	D	14	2500	330.0	16.4	6.5	9.0	2.1	8.0	16.0	Q1

TAPE AND REEL BOX DIMENSIONS

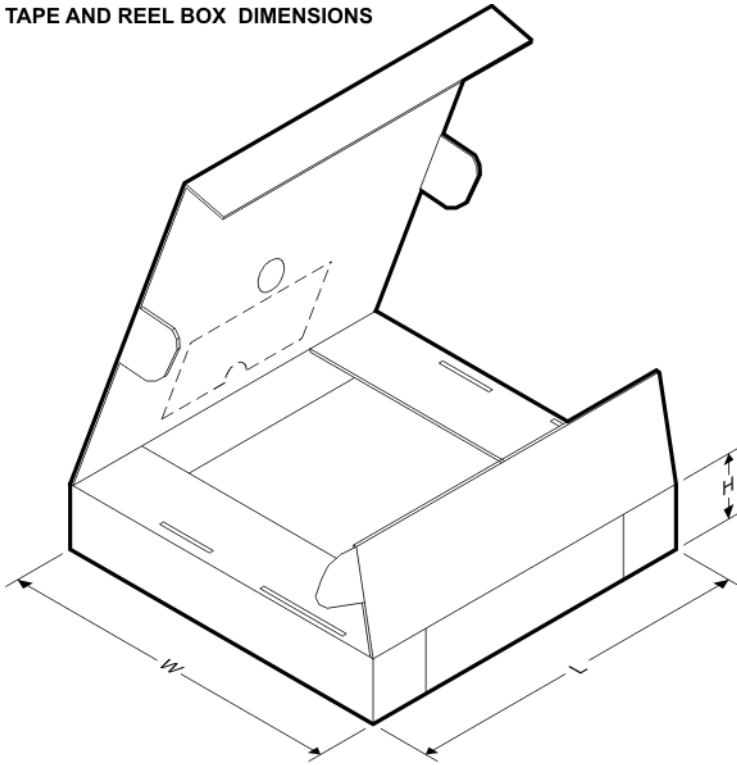

*All dimensions are nominal

Device	Package Type	Package Drawing	Pins	SPQ	Length (mm)	Width (mm)	Height (mm)
TL051CDR	SOIC	D	8	2500	340.5	338.1	20.6
TL052ACDR	SOIC	D	8	2500	340.5	338.1	20.6
TL052AIDR	SOIC	D	8	2500	340.5	338.1	20.6
TL052CDR	SOIC	D	8	2500	340.5	338.1	20.6
TL052CPSR	SO	PS	8	2000	346.0	346.0	33.0
TL052IDR	SOIC	D	8	2500	340.5	338.1	20.6
TL054ACDR	SOIC	D	14	2500	333.2	345.9	28.6
TL054AIDR	SOIC	D	14	2500	333.2	345.9	28.6
TL054CDBR	SSOP	DB	14	2000	346.0	346.0	33.0
TL054CDR	SOIC	D	14	2500	333.2	345.9	28.6
TL054CNSR	SO	NS	14	2000	346.0	346.0	33.0
TL054IDR	SOIC	D	14	2500	333.2	345.9	28.6

DB (R-PDSO-G**)

PLASTIC SMALL-OUTLINE

28 PINS SHOWN



- NOTES: A. All linear dimensions are in millimeters.
 B. This drawing is subject to change without notice.
 C. Body dimensions do not include mold flash or protrusion not to exceed 0,15.
 D. Falls within JEDEC MO-150

J (R-GDIP-T**)

14 LEADS SHOWN

CERAMIC DUAL IN-LINE PACKAGE



DIM \ PINS **	14	16	18	20
A	0.300 (7,62) BSC	0.300 (7,62) BSC	0.300 (7,62) BSC	0.300 (7,62) BSC
B MAX	0.785 (19,94)	.840 (21,34)	0.960 (24,38)	1.060 (26,92)
B MIN	—	—	—	—
C MAX	0.300 (7,62)	0.300 (7,62)	0.310 (7,87)	0.300 (7,62)
C MIN	0.245 (6,22)	0.245 (6,22)	0.220 (5,59)	0.245 (6,22)



4040083/F 03/03

- NOTES:
- All linear dimensions are in inches (millimeters).
 - This drawing is subject to change without notice.
 - This package is hermetically sealed with a ceramic lid using glass frit.
 - Index point is provided on cap for terminal identification only on press ceramic glass frit seal only.
 - Falls within MIL STD 1835 GDIP1-T14, GDIP1-T16, GDIP1-T18 and GDIP1-T20.

MECHANICAL DATA

NS (R-PDSO-G)**

PLASTIC SMALL-OUTLINE PACKAGE

14-PINS SHOWN



- NOTES:
- A. All linear dimensions are in millimeters.
 - B. This drawing is subject to change without notice.
 - C. Body dimensions do not include mold flash or protrusion, not to exceed 0,15.

FK (S-CQCC-N**)

LEADLESS CERAMIC CHIP CARRIER

28 TERMINAL SHOWN



4040140/D 10/96

- NOTES:
- A. All linear dimensions are in inches (millimeters).
 - B. This drawing is subject to change without notice.
 - C. This package can be hermetically sealed with a metal lid.
 - D. The terminals are gold plated.
 - E. Falls within JEDEC MS-004

D (R-PDSO-G8)

PLASTIC SMALL-OUTLINE PACKAGE

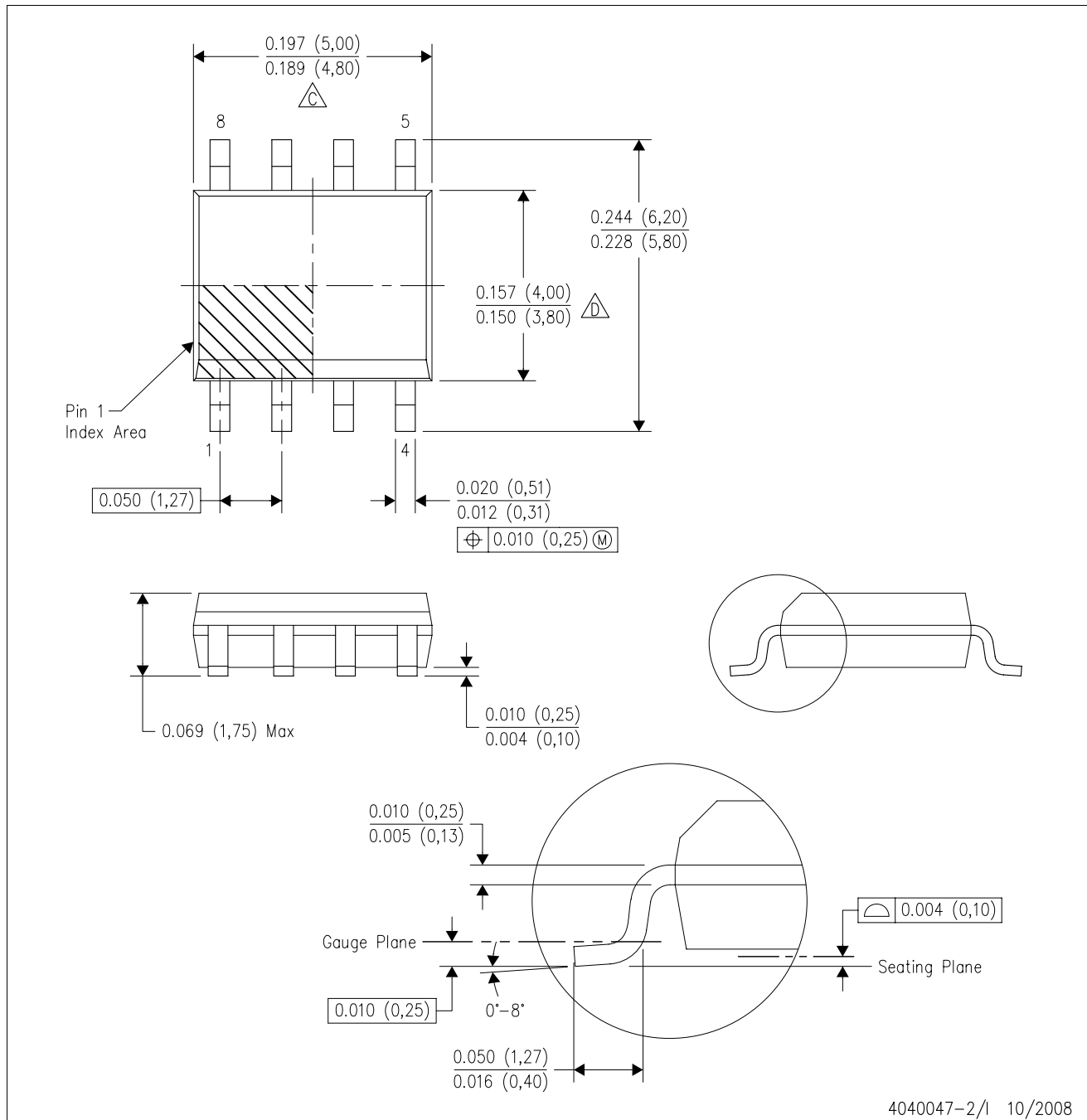

- NOTES:
- A. All linear dimensions are in inches (millimeters).
 - B. This drawing is subject to change without notice.
 - Body length does not include mold flash, protrusions, or gate burrs. Mold flash, protrusions, or gate burrs shall not exceed .006 (0,15) per end.
 - Body width does not include interlead flash. Interlead flash shall not exceed .017 (0,43) per side.
 - E. Reference JEDEC MS-012 variation AA.

MECHANICAL DATA

PS (R-PDSO-G8)

PLASTIC SMALL-OUTLINE PACKAGE



- NOTES:
- A. All linear dimensions are in millimeters.
 - B. This drawing is subject to change without notice.
 - C. Body dimensions do not include mold flash or protrusion, not to exceed 0,15.

D (R-PDSO-G14)

PLASTIC SMALL-OUTLINE PACKAGE

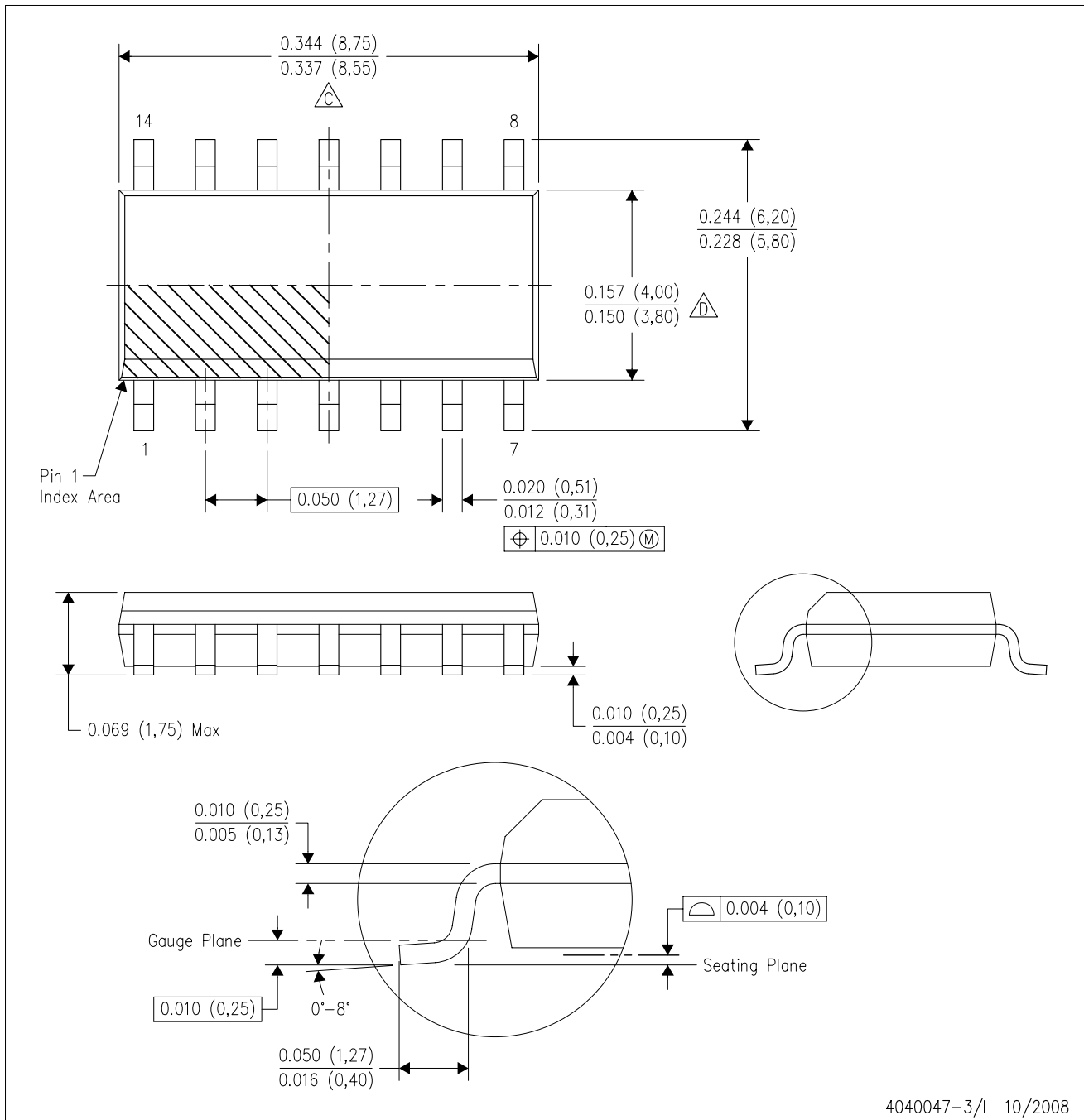

- NOTES:
- A. All linear dimensions are in inches (millimeters).
 - B. This drawing is subject to change without notice.
 - C. Body length does not include mold flash, protrusions, or gate burrs. Mold flash, protrusions, or gate burrs shall not exceed .006 (0,15) per end.
 - D. Body width does not include interlead flash. Interlead flash shall not exceed .017 (0,43) per side.
 - E. Reference JEDEC MS-012 variation AB.

P (R-PDIP-T8)

PLASTIC DUAL-IN-LINE



- NOTES: A. All linear dimensions are in inches (millimeters).
 B. This drawing is subject to change without notice.
 C. Falls within JEDEC MS-001

For the latest package information, go to http://www.ti.com/sc/docs/package/pkg_info.htm

JG (R-GDIP-T8)

CERAMIC DUAL-IN-LINE



- NOTES: A. All linear dimensions are in inches (millimeters).
 B. This drawing is subject to change without notice.
 C. This package can be hermetically sealed with a ceramic lid using glass frit.
 D. Index point is provided on cap for terminal identification.
 E. Falls within MIL STD 1835 GDIP1-T8

N (R-PDIP-T**)

PLASTIC DUAL-IN-LINE PACKAGE

16 PINS SHOWN



- NOTES:
- A. All linear dimensions are in inches (millimeters).
 - B. This drawing is subject to change without notice.
 - Falls within JEDEC MS-001, except 18 and 20 pin minimum body length (Dim A).
 - The 20 pin end lead shoulder width is a vendor option, either half or full width.

IMPORTANT NOTICE

Texas Instruments Incorporated and its subsidiaries (TI) reserve the right to make corrections, modifications, enhancements, improvements, and other changes to its products and services at any time and to discontinue any product or service without notice. Customers should obtain the latest relevant information before placing orders and should verify that such information is current and complete. All products are sold subject to TI's terms and conditions of sale supplied at the time of order acknowledgment.

TI warrants performance of its hardware products to the specifications applicable at the time of sale in accordance with TI's standard warranty. Testing and other quality control techniques are used to the extent TI deems necessary to support this warranty. Except where mandated by government requirements, testing of all parameters of each product is not necessarily performed.

TI assumes no liability for applications assistance or customer product design. Customers are responsible for their products and applications using TI components. To minimize the risks associated with customer products and applications, customers should provide adequate design and operating safeguards.

TI does not warrant or represent that any license, either express or implied, is granted under any TI patent right, copyright, mask work right, or other TI intellectual property right relating to any combination, machine, or process in which TI products or services are used. Information published by TI regarding third-party products or services does not constitute a license from TI to use such products or services or a warranty or endorsement thereof. Use of such information may require a license from a third party under the patents or other intellectual property of the third party, or a license from TI under the patents or other intellectual property of TI.

Reproduction of TI information in TI data books or data sheets is permissible only if reproduction is without alteration and is accompanied by all associated warranties, conditions, limitations, and notices. Reproduction of this information with alteration is an unfair and deceptive business practice. TI is not responsible or liable for such altered documentation. Information of third parties may be subject to additional restrictions.

Resale of TI products or services with statements different from or beyond the parameters stated by TI for that product or service voids all express and any implied warranties for the associated TI product or service and is an unfair and deceptive business practice. TI is not responsible or liable for any such statements.

TI products are not authorized for use in safety-critical applications (such as life support) where a failure of the TI product would reasonably be expected to cause severe personal injury or death, unless officers of the parties have executed an agreement specifically governing such use. Buyers represent that they have all necessary expertise in the safety and regulatory ramifications of their applications, and acknowledge and agree that they are solely responsible for all legal, regulatory and safety-related requirements concerning their products and any use of TI products in such safety-critical applications, notwithstanding any applications-related information or support that may be provided by TI. Further, Buyers must fully indemnify TI and its representatives against any damages arising out of the use of TI products in such safety-critical applications.

TI products are neither designed nor intended for use in military/aerospace applications or environments unless the TI products are specifically designated by TI as military-grade or "enhanced plastic." Only products designated by TI as military-grade meet military specifications. Buyers acknowledge and agree that any such use of TI products which TI has not designated as military-grade is solely at the Buyer's risk, and that they are solely responsible for compliance with all legal and regulatory requirements in connection with such use.

TI products are neither designed nor intended for use in automotive applications or environments unless the specific TI products are designated by TI as compliant with ISO/TS 16949 requirements. Buyers acknowledge and agree that, if they use any non-designated products in automotive applications, TI will not be responsible for any failure to meet such requirements.

Following are URLs where you can obtain information on other Texas Instruments products and application solutions:

Products

Amplifiers	amplifier.ti.com
Data Converters	dataconverter.ti.com
DSP	dsp.ti.com
Clocks and Timers	www.ti.com/clocks
Interface	interface.ti.com
Logic	logic.ti.com
Power Mgmt	power.ti.com
Microcontrollers	microcontroller.ti.com
RFID	www.ti-rfid.com
RF/IF and ZigBee® Solutions	www.ti.com/lprf

Applications

Audio	www.ti.com/audio
Automotive	www.ti.com/automotive
Broadband	www.ti.com/broadband
Digital Control	www.ti.com/digitalcontrol
Medical	www.ti.com/medical
Military	www.ti.com/military
Optical Networking	www.ti.com/opticalnetwork
Security	www.ti.com/security
Telephony	www.ti.com/telephony
Video & Imaging	www.ti.com/video
Wireless	www.ti.com/wireless

Mailing Address: Texas Instruments, Post Office Box 655303, Dallas, Texas 75265
Copyright © 2008, Texas Instruments Incorporated